



CALUX[®]
ILUMINA MEJOR

Catálogo 2023-2024



CALUX[®]
ILUMINA MEJOR

¡QUÉ BUENO ESTAR EN CASA!

Una casa bien iluminada es un espacio donde la luz se convierte en un elemento clave para realzar su belleza y funcionalidad, no solo mejora la estética del espacio, sino que también contribuye al bienestar y confort de quienes la habitan, creando una atmósfera acogedora y funcional para disfrutar plenamente de cada rincón del hogar.

Te acompañamos a llenar de luz esas experiencias e iluminar cada rincón por que Calux ilumina tu vida.





40



134



187

Contenido

- 06** **Línea de Mesa**
 - 06 Luminarias de Lectura

- 08** **Línea de TECHO**
 - 10 Colgantes LED
 - 14 Colgantes
 - 61 Candiles
 - 71 Plafones
 - 77 Sobreponer
 - 79 Sobreponer LED
 - 86 Empotrados LED
 - 90 Empotrados
 - 93 Lámparas LED vintage
 - 94 Lámparas LED
 - 95 Ventilador

- 96** **Línea de MURO**
 - 98 Cortesía LED
 - 107 Arbotantes
 - 114 Luminarias de lectura
 - 116 Arbotantes Dirigibles LED
 - 118 Arbotantes Dirigibles
 - 124 Luminarias y barras de baño LED
 - 126 Luminarias y barras de baño
 - 128 Arbotantes LED
 - 146 Arbotantes
 - 164 Faroles
 - 170 Reflectores LED

- 174** **Línea de PISO**
 - 177 Empotrados LED
 - 183 Empotrados
 - 186 Estacas LED
 - 187 Estacas
 - 188 Minipostes LED
 - 192 Minipostes
 - 194 Postes y faroles
 - 195 Postes

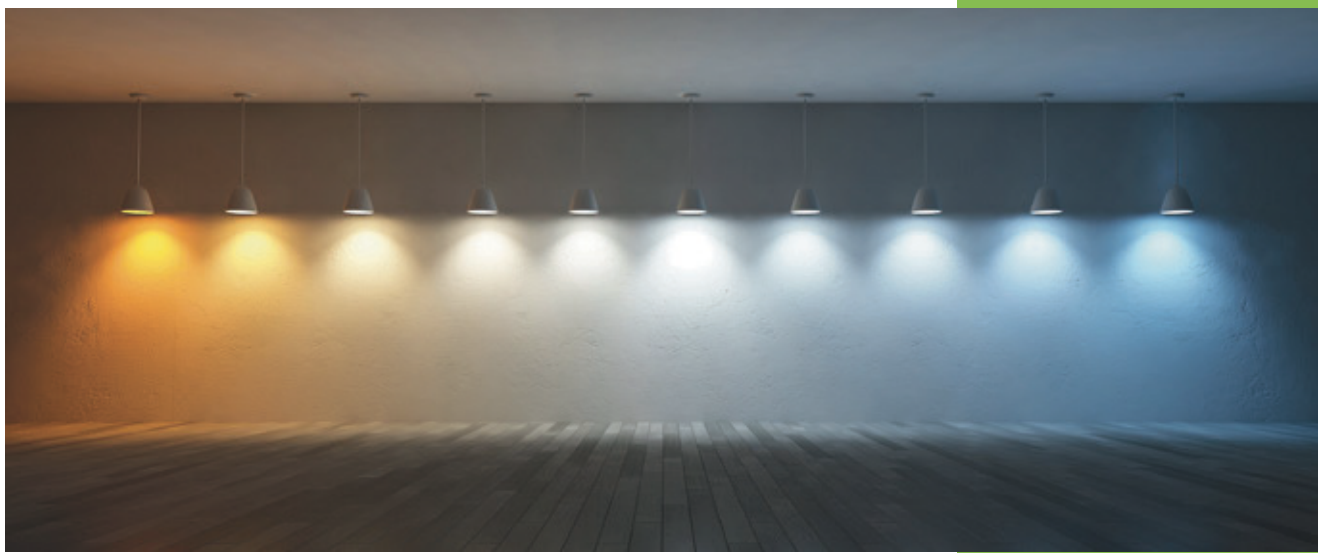

Iluminación a la medida

Siente el color

La temperatura de color se expresa en Kelvin, para el diseño de iluminación residencial nuestra recomendación como expertos es utilizar temperaturas que van desde 3,000 K (luz cálida) hasta 6,000 K (luz blanca). Una luz cálida nos dará la sensación de mayor confort y tranquilidad mientras que una luz blanca activa nuestros sentidos y brinda apoyo para la realización de tareas específicas.

¿Sabes qué significa el IP?

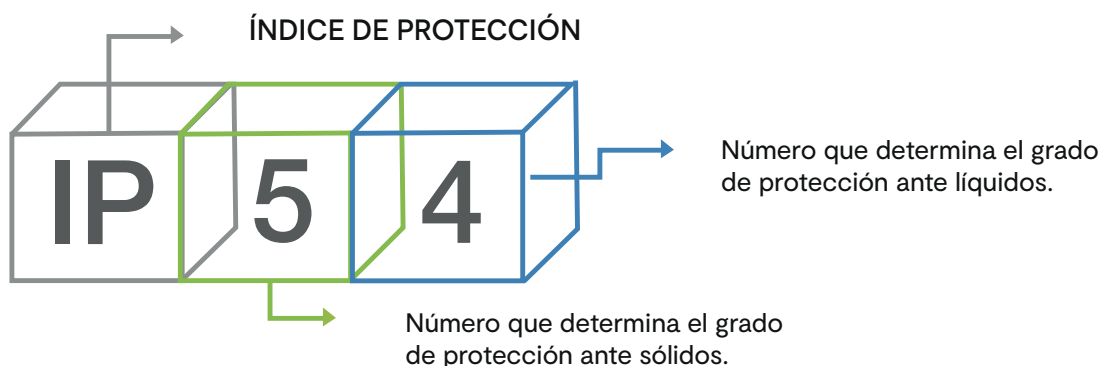

1ER DÍGITO: PROTECCIÓN ANTE SÓLIDOS	
0	Sin protección
1	Protección ante objetos de diámetro superior a 50 MM
2	Protección ante objetos de diámetro superior a 12 MM
3	Protección ante objetos con diámetro superior a 2.5 MM
4	Protección ante objetos con diámetro superior a 1 MM
5	Protegido contra ingreso limitado de polvo
6	Totalmente protegido contra el polvo

2DO DÍGITO : PROTECCIÓN ANTE LIQUIDOS	
0	Sin protección
1	Protección ante goteo vertical o condensación
2	Protección ante goteo con una inclinación de 15 grados
3	Protección ante goteo con una inclinación de 60 grados
4	Protección ante salpicaduras de gotas en todas direcciones
5	Protección ante chorros de agua a baja presión
6	Protección ante potentes y continuos chorros de agua
7	Protección ante inmersiones temporales
8	Protección ante inmersiones prolongadas o permanentes

Iconografía Calux



Los íconos CALUX te permiten identificar las características de nuestros productos de manera más fácil y rápida para ayudarte en tu elección.



Garantía de 3 años en todos los productos de la línea LED.



Garantía de 1 año en todos nuestros productos excepción línea LED.

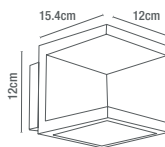

Medidas detalladas del producto.



Este ícono te indica cuando el producto ilumina hacia arriba y hacia dos lados.

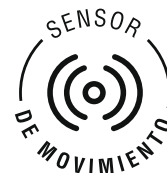

Luminarias que encienden al detectar movimiento físico.



Identifica los productos de nuevo lanzamiento.



Productos mexicanos, apoyamos lo nacional.



Te indica cuando una luminaria tiene tecnología luz solar por panel led.



Productos que cuentan con tecnología LED.



Luminarias que emiten luz por reflexión.



Este ícono especifica que la luminaria tiene una luz dirigida.



Productos que solo pueden ser utilizados en interiores.



Te indica que la instalación de este producto va sobrepuesto sobre alguna superficie.



Productos que tienen una mayor resistencia para climas húmedos o de temperaturas extremas.



Luminarias que para su instalación necesitan corte de empotramiento.



Enciende y apaga la luz de forma manual con un solo toque en la placa.



Productos que se encienden y apagan con interruptor switch.



Luminarias que disponen de ranuras para la inserción de clavijas.



Disfruta del beneficio adicional de poner a cargar tu celular gracias a la entrada USB que cuentan algunas de nuestras luminarias.

Todos los productos que no son con led integrado **no incluyen lámpara**.

*CALUX se reserva el derecho de hacer modificaciones menores en los productos sin previo aviso.

*Las imágenes que se muestran en el catálogo son solo con fines ilustrativos.

*Se prohíbe la reproducción total o parcial de este catálogo por cualquier medio.

www.calux.com.mx





LM3310-LED/GF

LUMINARIAS PARA ESCRITORIO

Material: Aluminio
Terminado: Blanco y Grafito



LM3310-LED/GF



LM3310-LED/BL

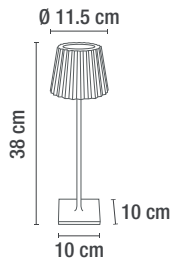

No puede faltar, su practicidad y resistencia la hace perfecta para habitaciones, estancias, terrazas, exteriores. Toda la iluminación con un touch.

ENCENDIDO Y DIMEABLE



MICRO USB PARA CARGA INCLUYE CABLE DE CARGA

CÓDIGO	DESCRIPCIÓN	APLICACIÓN	MATERIA PRIMA	TERMINADO	POTENCIA MÁX. (W)	VOLTAJE (RANGO)	VAC-Hz	IP	ÁNGULO DE APERTURA	LUMENS (lm)
LM3310-LED/BL LM3310-LED/GF	LUMINARIA LED TOUCH CON ATENUADOR PARA MESA	EXTERIOR	ALUMINIO / ALUMINIO/ POLICARBONATO	BLANCO GRAFITO	2.2	3.7 V DC	9 Hz	54	45°	180 lm





- 10 Colgantes LED
- 14 Colgantes
- 61 Candiles
- 71 Plafones
- 77 Sobreponer
- 79 Sobreponer LED
- 86 Empotrados LED
- 90 Empotrados
- 93 Lámparas LED vintage
- 94 Lámparas LED
- 95 Ventilador

Luminarias de Techo

Vanguardia, tendencia y practicidad son una de las mejores características de nuestra colección de luminarias de techo, los espacios lucen con mayor intensidad y belleza a través de tecnología que vuelve los proyectos más eficientes energéticamente y respetuosos con el medio ambiente.



CL-3010-LED/BL

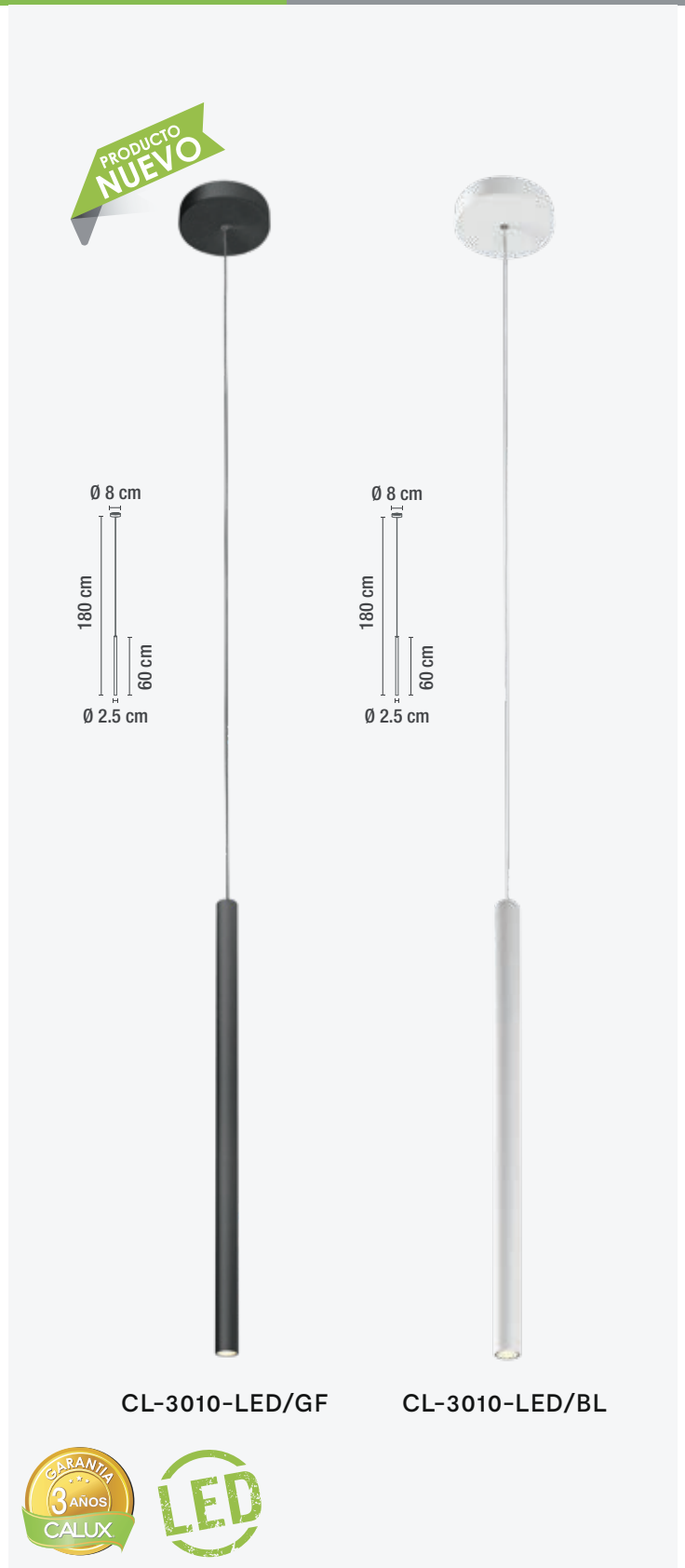

CL-3010-LED/GF

CL-3010-LED/BL



CÓDIGO	DESCRIPCIÓN	APLICACIÓN	MATERIA PRIMA	TERMINADO	POTENCIA MÁX. (W)	VOLTAJE (RANGO)	VAC-Hz	VIDA PROMEDIO (h)	ÁNGULO DE APERTURA	LUMENS (lm)	TEMPERATURA (K)
CL-3010-LED/GF CL-3010-LED/BL	LUMINARIA DE LED SUSPENDIDA PARA TECHO	INTERIOR	ALUMINIO	GRAFITO BLANCO	4 W	100-240 V~	50-60 Hz	30000 h	20°	335 lm	3 000 K

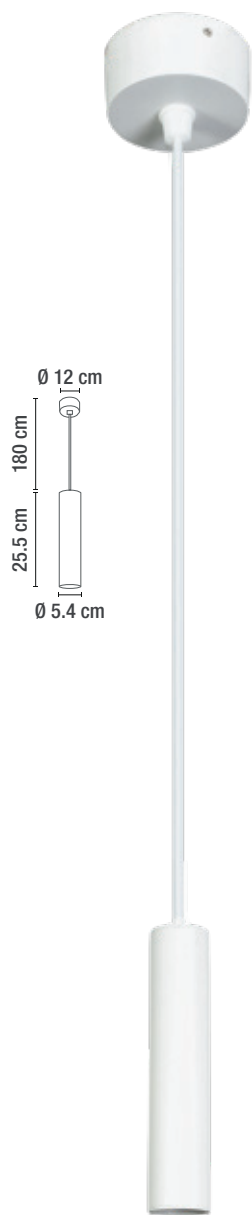

CL3011LED/BL

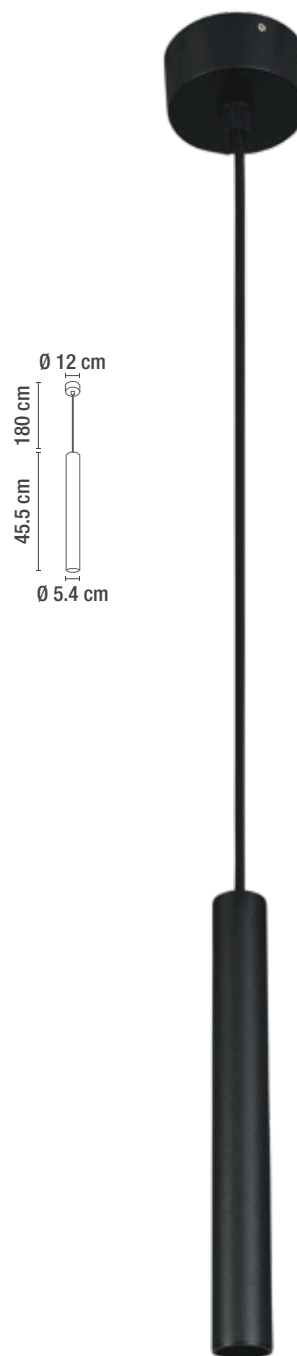

CL3015LED/NE



*DISPONIBLE EN NEGRO



CÓDIGO	DESCRIPCIÓN	APLICACIÓN	MATERIA PRIMA	TERMINADO	POTENCIA MÁX. (W)	VOLTAJE (RANGO)	VAC-HZ	VIDA PROMEDIO (h)	ÁNGULO DE APERTURA	LUMENS	TEMPERATURA (K)
CL3011LED/BL CL3011LED/NE	LUMINARIA DE LED SUSPENDIDA PARA TECHO	INTERIOR	ALUMINIO - POLICARBONATO	BLANCO NEGRO	7 W	100-240 V~	50-60 Hz	30000 h	24°	735 lm	3 000 K
CL3015LED/NE	LUMINARIA DE LED SUSPENDIDA PARA TECHO	INTERIOR	ALUMINIO - POLICARBONATO	NEGRO	10 W	100-240 V~	50-60 Hz	30000 h	24°	800 lm	3 000 K



CL-1085-LED/CR

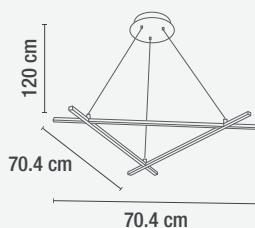

CL-1085-LED/CR

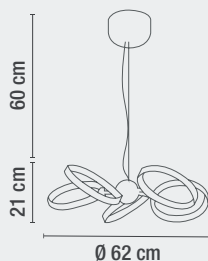

CL-0236-5-LED/SA

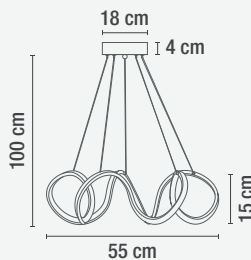

CL-3012-LED/NE



CÓDIGO	DESCRIPCIÓN	APLICACIÓN	MATERIA PRIMA	TERMINADO	POTENCIA MÁX. (W)	VOLTAJE (RANGO)	VAC-Hz	VIDA PROMEDIO (h)	LUMENS (lm)	TEMPERATURA (K)
CL-1085-LED/CR	LUMINARIA DE LED SUSPENDIDA PARA TECHO	INTERIOR	ALUMINIO/ ACERO - POLICARBONATO	CROMO	30 W	100-240 V~	50-60 Hz	20000 h	2100 lm	3 000 K
CL-0236-5-LED/SA	LUMINARIA DE LED SUSPENDIDA PARA TECHO	INTERIOR	ALUMINIO - POLICARBONATO	SATINADO	35 W	100-240 V~	50-60 Hz	30000 h	1800 lm	3 000 K
CL-3012-LED/NE	LUMINARIA DE LED SUSPENDIDA PARA TECHO	INTERIOR	ALUMINIO - POLICARBONATO	NEGRO	42 W	100-240 V~	50-60 Hz	30000 h	2 500 lm	3 000 K



CL-3026-LED/CR



LUMINARIA MULTIFORMAS

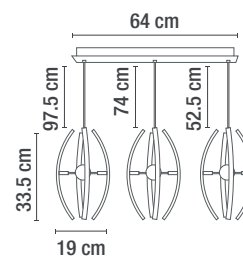

CL-6565-LED/CR



LUMINARIA MULTIFORMAS

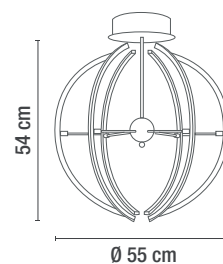

CÓDIGO	DESCRIPCIÓN	APLICACIÓN	MATERIA PRIMA	TERMINADO	POTENCIA MÁX. (W)	VOLTAJE (RANGO)	VAC-HZ	VIDA PROMEDIO (h)	LUMENS	TEMPERATURA (K)
CL-3026-LED/CR	LUMINARIA DE LED SUSPENDIDA PARA TECHO	INTERIOR	ALUMINIO/ ACERO - POLICARBONATO	CROMO	50 W	100-240 V~	50-60 Hz	20000 h	3500 lm	3 000 K
CL-6565-LED/CR	LUMINARIA DE LED SUSPENDIDA PARA TECHO	INTERIOR	ALUMINIO/ ACERO - POLICARBONATO	CROMO	50 W	100-240 V~	50-60 Hz	20000 h	3500 lm	3 000 K



C2036-10/NE

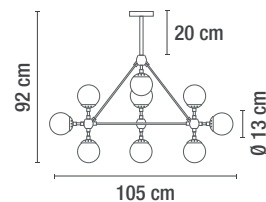

C2036-10/NE

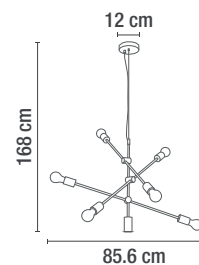

C3022-6/BRZ



*ESTAS LUMINARIAS NO INCLUYEN LÁMPARAS

CÓDIGO	DESCRIPCIÓN	APLICACIÓN	MATERIA PRIMA	TERMINADO	POTENCIA MÁX. (W)	VOLTAJE (RANGO)	VAC-Hz	TIPO DE SOCKET	No. DE SOCKET
C2036-10/NE	LUMINARIA SUSPENDIDA PARA TECHO	INTERIOR	ACERO - CRISTAL	NEGRO	400 W	127 V~	50-60 Hz	E27	10
C3022-6/BRZ	LUMINARIA SUSPENDIDA PARA TECHO	INTERIOR	ACERO	COBRE	240 W	125 V~	50-60 Hz	E27	6

PRODUCTO
NUEVO



C2038-6/NE

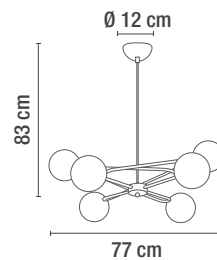

C2038-6/CR

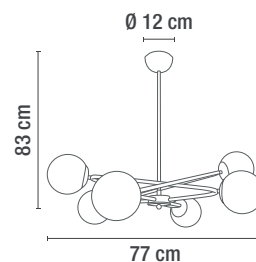

*ESTAS LUMINARIAS NO INCLUYEN LÁMPARAS

CÓDIGO	DESCRIPCIÓN	APLICACIÓN	MATERIA PRIMA	TERMINADO	POTENCIA MÁX. (W)	VOLTAJE (RANGO)	VAC-Hz	TIPO DE SOCKET	No. DE SOCKET
C2038-6/NE C2038-6/CR	LUMINARIA SUSPENDIDA PARA TECHO	INTERIOR	ACERO - CRISTAL	NEGRO CROMO	240 W	127 V~	50-60 Hz	E27	6

PRODUCTO
NUEVO

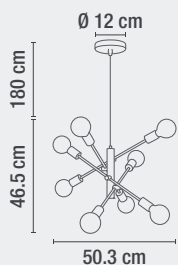

C2050-8/OR

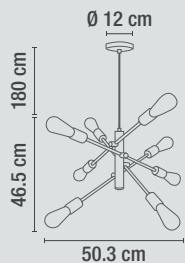

C2050-8/BL

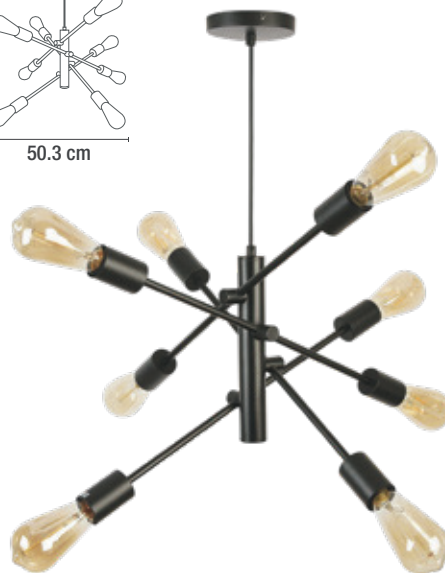
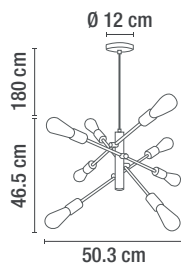

C2050-8/NE

*ESTAS LUMINARIAS NO INCLUYEN LÁMPARAS



CÓDIGO	DESCRIPCIÓN	APLICACIÓN	MATERIA PRIMA	TERMINADO	POTENCIA MÁX. (W)	VOLTAJE (RANGO)	VAC-Hz	TIPO DE SOCKET	No. DE SOCKET
C2050-8/OR C2050-8/BL C2050-8/NE	LUMINARIA SUSPENDIDA PARA TECHO	INTERIOR	ACERO	NEGRO Y ORO BLANCO NEGRO	320 W	125 V~ 127 V~ 127 V~	50-60 Hz	E27	8



C2080-8/LC

PRODUCTO
NUEVO



C2080-8/LC

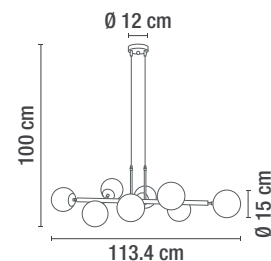

PRODUCTO
NUEVO



C2080-8/NE

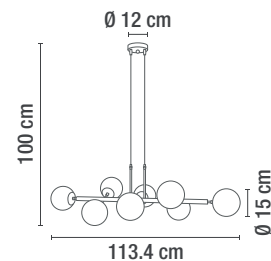

CÓDIGO	DESCRIPCIÓN	APLICACIÓN	MATERIA PRIMA	TERMINADO	POTENCIA MÁX. (W)	VOLTAJE (RANGO)	VAC-HZ	TIPO DE SOCKET	No. DE SOCKET
C2080-8/LC C2080-8/NE	LUMINARIA SUSPENDIDA PARA TECHO	INTERIOR	ACERO / CRISTAL	LATÓN NEGRO	480 W	127 V~	50-60 Hz	E27	8

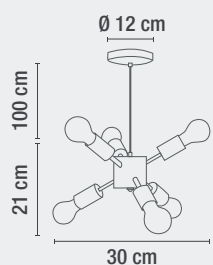

C2040-6/BL

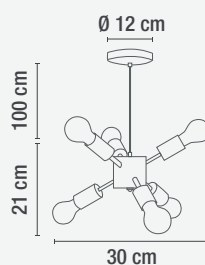

C2040-6/NE

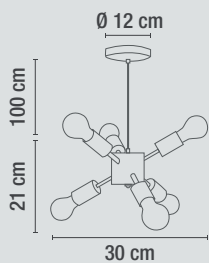

C2040-6/OR



*ESTAS LUMINARIAS NO INCLUYEN LÁMPARAS

CÓDIGO	DESCRIPCIÓN	APLICACIÓN	MATERIA PRIMA	TERMINADO	POTENCIA MÁX. (W)	VOLTAJE (RANGO)	VAC-Hz	TIPO DE SOCKET	No. DE SOCKET
C2040-6/BL C2040-6/NE C2040-6/OR	LUMINARIA SUSPENDIDA PARA TECHO	INTERIOR	ACERO	BLANCO NEGRO NEGRO Y ORO	240 W	127 V~ 127 V~ 125 V~	50-60 Hz	E27	6

PRODUCTO
NUEVO

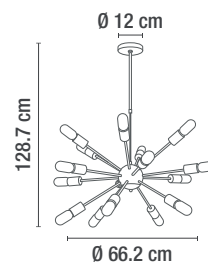

C2060-16/NE

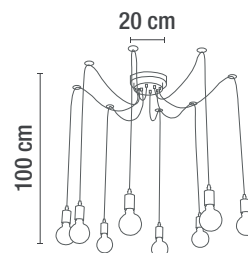

C2030-8/NE



*ESTAS LUMINARIAS NO INCLUYEN LÁMPARAS

CÓDIGO	DESCRIPCIÓN	APLICACIÓN	MATERIA PRIMA	TERMINADO	POTENCIA MÁX. (W)	VOLTAJE (RANGO)	VAC-Hz	TIPO DE SOCKET	No. DE SOCKET
C2060-16/NE	LUMINARIA SUSPENDIDA PARA TECHO	INTERIOR	ACERO	NEGRO	640 W	125 V~	50-60 Hz	E27	16
C2030-8/NE	LUMINARIA SUSPENDIDA PARA TECHO	INTERIOR	ACERO	NEGRO	320 W	125 V~	50-60 Hz	E27	8



C2029-5/GR

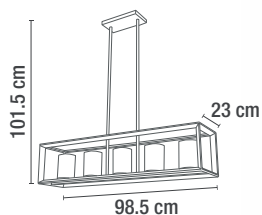

C2031-4/GR

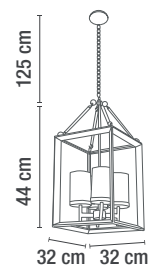

C2028-4/N

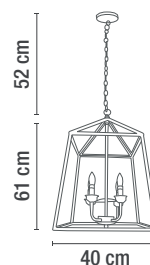

CÓDIGO	DESCRIPCIÓN	APLICACIÓN	MATERIA PRIMA	TERMINADO	POTENCIA MÁX. (W)	VOLTAJE (RANGO)	VAC-Hz	TIPO DE SOCKET	No. DE SOCKET
C2029-5/GR	LUMINARIA SUSPENDIDA PARA TECHO	INTERIOR	ACERO - CRISTAL	GRIS	300 W	100-240 V~	50-60 Hz	E27	5
C2031-4/GR	LUMINARIA SUSPENDIDA PARA TECHO	INTERIOR	ACERO - CRISTAL	GRIS	240 W	100-240 V~	50-60 Hz	E27	4
C2028-4/N	CANDIL SUSPENDIDO	INTERIOR	ACERO	NEGRO	100 W	127 V~	50-60 Hz	E12	4

Hecho en México

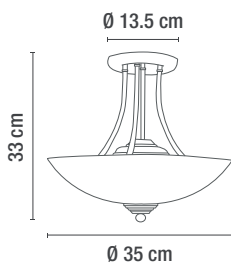

PIT/S

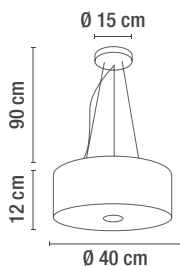

V2750



CÓDIGO	DESCRIPCIÓN	APLICACIÓN	MATERIA PRIMA	TERMINADO	POTENCIA MÁX. (W)	VOLTAJE (RANGO)	VAC-Hz	TIPO DE SOCKET	No. DE SOCKET
PIT/S	LUMINARIA SUSPENDIDA PARA TECHO	INTERIOR	ACERO - CRISTAL ÁCIDO	SATINADO	180 W	127 V~	50-60 Hz	E27	3
V2750	LUMINARIA SUSPENDIDA PARA TECHO	INTERIOR	ACERO - CRISTAL	INOX	180 W	127 V~	50-60 Hz	E27	3



CFG5L/NE

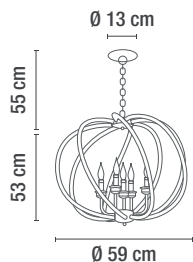

Hecho en México



CFG5L/NE

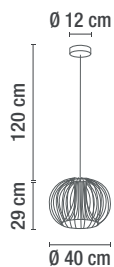

C084/NE



CÓDIGO	DESCRIPCIÓN	APLICACIÓN	MATERIA PRIMA	TERMINADO	POTENCIA MÁX. (W)	VOLTAJE (RANGO)	VAC-Hz	TIPO DE SOCKET	No. DE SOCKET
CFG5L/NE	LUMINARIA SUSPENDIDA PARA TECHO	INTERIOR	ACERO	NEGRO	125 W	127 V~	50-60 Hz	E12	5
C084/NE	LUMINARIA SUSPENDIDA PARA TECHO	INTERIOR	ACERO	NEGRO	60 W	100-240 V~	50-60 Hz	E27	1

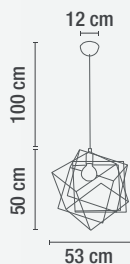

C082/NE

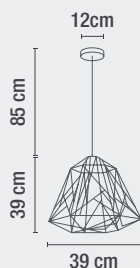

C076/NE



*ESTAS LUMINARIAS NO INCLUYEN LÁMPARAS



C076/NE

CÓDIGO	DESCRIPCIÓN	APLICACIÓN	MATERIA PRIMA	TERMINADO	POTENCIA MÁX. (W)	VOLTAJE (RANGO)	VAC-Hz	TIPO DE SOCKET	No. DE SOCKET
C082/NE	LUMINARIA SUSPENDIDA PARA TECHO	INTERIOR	ACERO	NEGRO	40 W	125 V~	50-60 Hz	E27	1
C076/NE	LUMINARIA SUSPENDIDA PARA TECHO	INTERIOR	ACERO	NEGRO	40 W	125 V~	50-60 Hz	E27	1



C302/NE-3



C079/NE

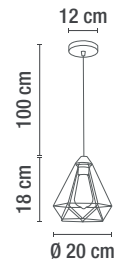

PRODUCTO
NUEVO



C302/NE-3

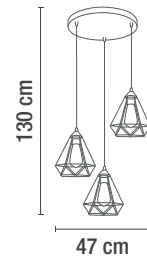

*ESTAS LUMINARIAS NO INCLUYEN LÁMPARAS

CÓDIGO	DESCRIPCIÓN	APLICACIÓN	MATERIA PRIMA	TERMINADO	POTENCIA MÁX. (W)	VOLTAJE (RANGO)	VAC-Hz	TIPO DE SOCKET	No. DE SOCKET
C079/NE	LUMINARIA SUSPENDIDA PARA TECHO	INTERIOR	ACERO	NEGRO	40 W	125 V~	50-60 Hz	E27	1
C302/NE-3	LUMINARIA SUSPENDIDA PARA TECHO	INTERIOR	ACERO	NEGRO	120 W	125 V~	50-60 Hz	E27	3



C081/NE

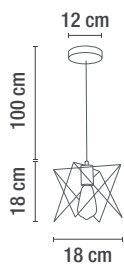

C078/NE

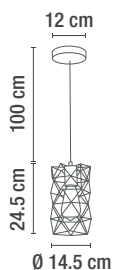

C080/NE

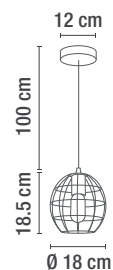

*ESTAS LUMINARIAS NO INCLUYEN LÁMPARAS

CÓDIGO	DESCRIPCIÓN	APLICACIÓN	MATERIA PRIMA	TERMINADO	POTENCIA MÁX. (W)	VOLTAJE (RANGO)	VAC-Hz	TIPO DE SOCKET	No. DE SOCKET
C081/NE	LUMINARIA SUSPENDIDA PARA TECHO	INTERIOR	ACERO	NEGRO	40 W	125 V~	50-60 Hz	E27	1
C078/NE	LUMINARIA SUSPENDIDA PARA TECHO	INTERIOR	ACERO	NEGRO	40 W	125 V~	50-60 Hz	E27	1
C080/NE	LUMINARIA SUSPENDIDA PARA TECHO	INTERIOR	ACERO	NEGRO	40 W	125 V~	50-60 Hz	E27	1



C303/NE-3



C083/NE

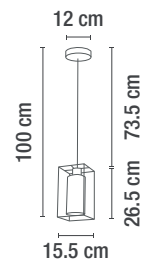

PRODUCTO
NUEVO



C303/NE-3

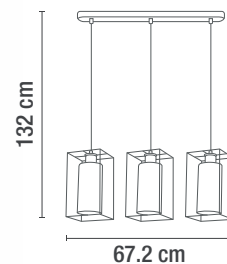

CÓDIGO	DESCRIPCIÓN	APLICACIÓN	MATERIA PRIMA	TERMINADO	POTENCIA MÁX. (W)	VOLTAJE (RANGO)	VAC-Hz	TIPO DE SOCKET	No. DE SOCKET
C083/NE	LUMINARIA SUSPENDIDA PARA TECHO	INTERIOR	ACERO - CRISTAL	NEGRO	40 W	125 V~	50-60 Hz	E27	1
C303/NE-3	LUMINARIA SUSPENDIDA PARA TECHO	INTERIOR	ACERO - CRISTAL	NEGRO	120 W	125 V~	50-60 Hz	E27	3

PRODUCTO NUEVO

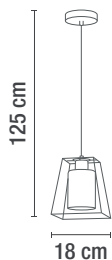

C312/NE

PRODUCTO NUEVO

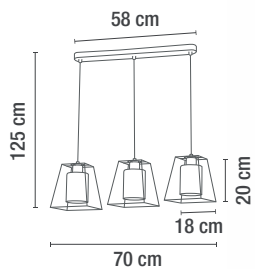

C313/NE-3



C312/NE

CÓDIGO	DESCRIPCIÓN	APLICACIÓN	MATERIA PRIMA	TERMINADO	POTENCIA MÁX. (W)	VOLTAJE (RANGO)	VAC-Hz	TIPO DE SOCKET	No. DE SOCKET
C312/NE	LUMINARIA SUSPENDIDA PARA TECHO	INTERIOR	ACERO - CRISTAL	NEGRO Y HUMO	40 W	125 V~	50-60 Hz	E27	1
C313/NE-3	LUMINARIA SUSPENDIDA PARA TECHO	INTERIOR	ACERO - CRISTAL	NEGRO Y HUMO	120 W	125 V~	50-60 Hz	E27	3

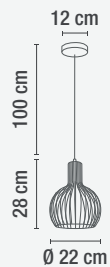

C077/NE

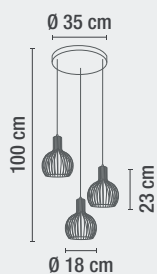

C077/NE-3



CÓDIGO	DESCRIPCIÓN	APLICACIÓN	MATERIA PRIMA	TERMINADO	POTENCIA MÁX. (W)	VOLTAJE (RANGO)	VAC-Hz	TIPO DE SOCKET	No. DE SOCKET
C077/NE	LUMINARIA SUSPENDIDA PARA TECHO	INTERIOR	ACERO - ACERO	NEGRO	40 W	125 V~	50-60 Hz	E27	1
C077/NE-3	LUMINARIA SUSPENDIDA PARA TECHO	INTERIOR	ACERO - ACERO	NEGRO	120 W	125 V~	50-60 Hz	E27	3

PRODUCTO
NUEVO

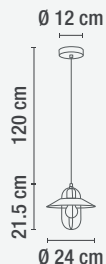

C308/NE

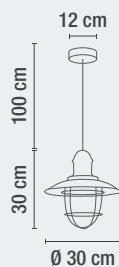

C060/NE



C308/NE

CÓDIGO	DESCRIPCIÓN	APLICACIÓN	MATERIA PRIMA	TERMINADO	POTENCIA MÁX. (W)	VOLTAJE (RANGO)	VAC-Hz	TIPO DE SOCKET	No. DE SOCKET
C308/NE	LUMINARIA SUSPENDIDA PARA TECHO	INTERIOR	ACERO	NEGRO Y ORO	40 W	125 V~	50-60 Hz	E27	1
C060/NE	LUMINARIA SUSPENDIDA PARA TECHO	INTERIOR	ACERO	NEGRO	40 W	125 V~	50-60 Hz	E27	1

PRODUCTO
NUEVO



C061/NE

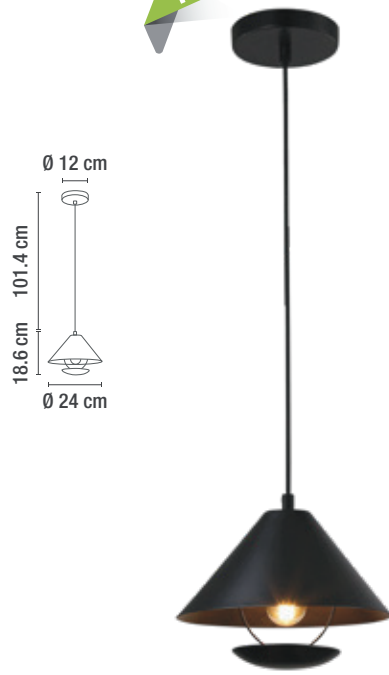

C342/NE

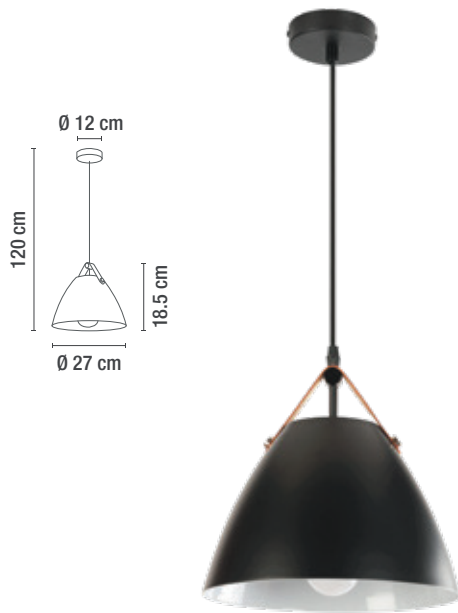

C227/NE



CÓDIGO	DESCRIPCIÓN	APLICACIÓN	MATERIA PRIMA	TERMINADO	POTENCIA MÁX. (W)	VOLTAJE (RANGO)	VAC-Hz	TIPO DE SOCKET	No. DE SOCKET
C061/NE	LUMINARIA SUSPENDIDA PARA TECHO	INTERIOR	ACERO	NEGRO	40 W	125 V~	50-60 Hz	E27	1
C342/NE	LUMINARIA SUSPENDIDA PARA TECHO	INTERIOR	ACERO	NEGRO	40 W	125 V~	50-60 Hz	E27	1
C227/NE	LUMINARIA SUSPENDIDA PARA TECHO	INTERIOR	ACERO	NEGRO	25 W	125 V~	50-60 Hz	E27	1



C361/NE-3

PRODUCTO
NUEVO



C362/NE

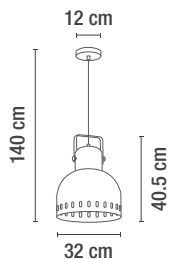

PRODUCTO
NUEVO



C361/NE-3

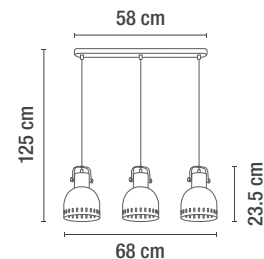

CÓDIGO	DESCRIPCIÓN	APLICACIÓN	MATERIA PRIMA	TERMINADO	POTENCIA MÁX. (W)	VOLTAJE (RANGO)	VAC-Hz	TIPO DE SOCKET	No. DE SOCKET
C362/NE	LUMINARIA SUSPENDIDA PARA TECHO	INTERIOR	ACERO	NEGRO Y ORO	40 W	125 V~	50-60 Hz	E27	1
C361/NE-3	LUMINARIA SUSPENDIDA PARA TECHO	INTERIOR	ACERO	NEGRO Y ORO	120 W	125 V~	50-60 Hz	E27	3



C219/NE

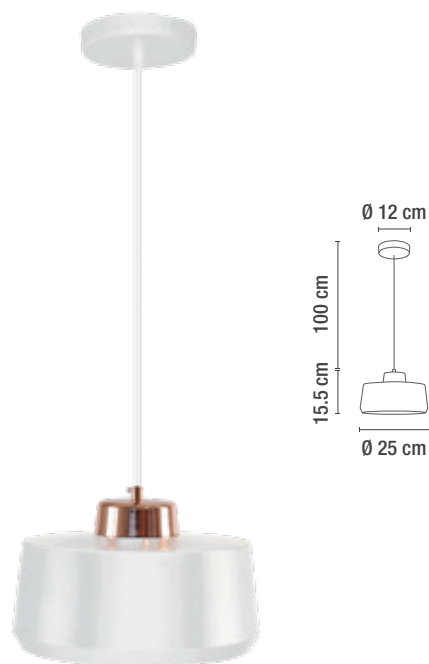

C219/BL

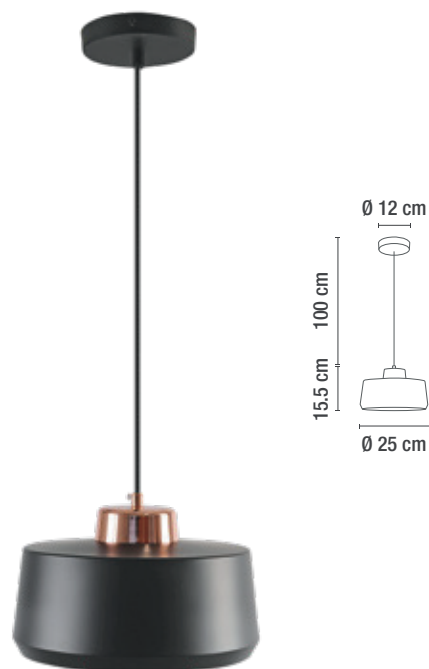

C219/NE

CÓDIGO	DESCRIPCIÓN	APLICACIÓN	MATERIA PRIMA	TERMINADO	POTENCIA MÁX. (W)	VOLTAJE (RANGO)	VAC-Hz	TIPO DE SOCKET	No. DE SOCKET
C219/BL C219/NE	LUMINARIA SUSPENDIDA PARA TECHO	INTERIOR	ACERO	BLANCO NEGRO	40 W	125 V~	50-60 Hz	E27	1

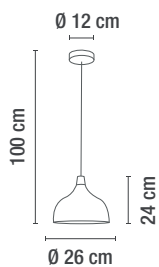

C223/NE

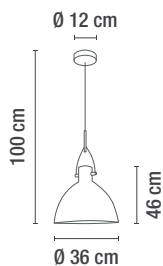

C226/BL

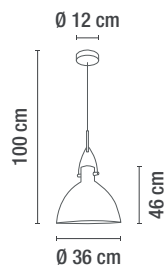

C226/NE



CÓDIGO	DESCRIPCIÓN	APLICACIÓN	MATERIA PRIMA	TERMINADO	POTENCIA MÁX. (W)	VOLTAJE (RANGO)	VAC-Hz	TIPO DE SOCKET	No. DE SOCKET
C223/NE	LUMINARIA SUSPENDIDA PARA TECHO	INTERIOR	ACERO	NEGRO	40 W	125 V~	50-60 Hz	E27	1
C226/BL C226/NE	LUMINARIA SUSPENDIDA PARA TECHO	INTERIOR	ACERO	BLANCO NEGRO	40 W	125 V~	50-60 Hz	E27	1



C224/RO

PRODUCTO
NUEVO



C222/NE

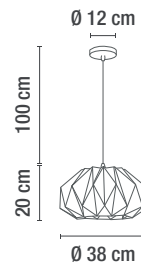

C224/RO

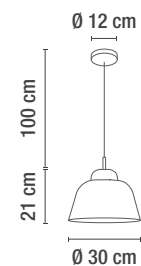

CÓDIGO	DESCRIPCIÓN	APLICACIÓN	MATERIA PRIMA	TERMINADO	POTENCIA MÁX. (W)	VOLTAJE (RANGO)	VAC-Hz	TIPO DE SOCKET	No. DE SOCKET
C222/NE C222/BL	LUMINARIA SUSPENDIDA PARA TECHO	INTERIOR	ACERO	NEGRO BLANCO	40 W	125 V~	50-60 Hz	E27	1
C224/RO	LUMINARIA SUSPENDIDA PARA TECHO	INTERIOR	ACERO	ROSA	40 W	125 V~	50-60 Hz	E27	1

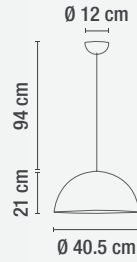

V2050

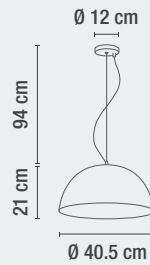

V2050/NE



V2050/NE

CÓDIGO	DESCRIPCIÓN	APLICACIÓN	MATERIA PRIMA	TERMINADO	POTENCIA MÁX. (W)	VOLTAJE (RANGO)	VAC-Hz	TIPO DE SOCKET	No. DE SOCKET
V2050 V2050/NE	LUMINARIA SUSPENDIDA PARA TECHO	INTERIOR	ACERO	BLANCO NEGRO	60 W	127 V~	50-60 Hz	E27	1



V2032

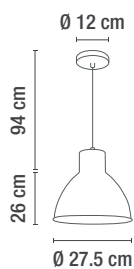

V2046/OR

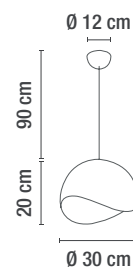

CÓDIGO	DESCRIPCIÓN	APLICACIÓN	MATERIA PRIMA	TERMINADO	POTENCIA MÁX. (W)	VOLTAJE (RANGO)	VAC-Hz	TIPO DE SOCKET	No. DE SOCKET
V2032	LUMINARIA SUSPENDIDA PARA TECHO	INTERIOR	ACERO	CONCRETO	60 W	127 V~	50-60 Hz	E27	1
V2046/OR	LUMINARIA SUSPENDIDA PARA TECHO	INTERIOR	ACERO	ORO ROSADO	60 W	127 V~	50-60 Hz	E27	1

PRODUCTO
NUEVO



V2020

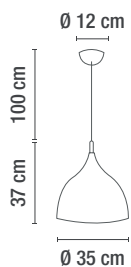

V2020/NE

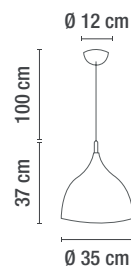

CÓDIGO	DESCRIPCIÓN	APLICACIÓN	MATERIA PRIMA	TERMINADO	POTENCIA MÁX. (W)	VOLTAJE (RANGO)	VAC-Hz	TIPO DE SOCKET	No. DE SOCKET
V2020 V2020/NE	LUMINARIA SUSPENDIDA PARA TECHO	INTERIOR	ACERO	CROMO NEGRO	60 W	127 V~	50-60 Hz	E27	1



V2024/NEG



V2024

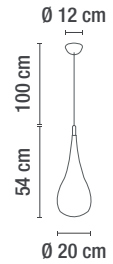

V2024/NEG

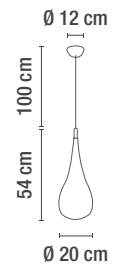

CÓDIGO	DESCRIPCIÓN	APLICACIÓN	MATERIA PRIMA	TERMINADO	POTENCIA MÁX. (W)	VOLTAJE (RANGO)	VAC-Hz	TIPO DE SOCKET	No. DE SOCKET
V2024 V2024/NEG	LUMINARIA SUSPENDIDA PARA TECHO	INTERIOR	ACERO	CROMO NEGRO	60 W	127 V~	50-60 Hz	E27	1

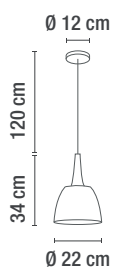

C217/ORM

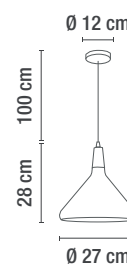

C218/ORM



CÓDIGO	DESCRIPCIÓN	APLICACIÓN	MATERIA PRIMA	TERMINADO	POTENCIA MÁX. (W)	VOLTAJE (RANGO)	VAC-Hz	TIPO DE SOCKET	No. DE SOCKET
C217/ORM	LUMINARIA SUSPENDIDA PARA TECHO	INTERIOR	ACERO/ROBLE	CHAMPAGNE	40 W	125 V~	50-60 Hz	E27	1
C218/ORM	LUMINARIA SUSPENDIDA PARA TECHO	INTERIOR	ALUMINIO	CHAMPAGNE	40 W	125 V~	50-60 Hz	E27	1

PRODUCTO NUEVO

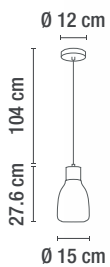

C307/HU

PRODUCTO NUEVO

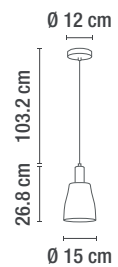

C351/HU

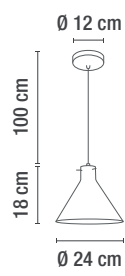

C090/HU



CÓDIGO	DESCRIPCIÓN	APLICACIÓN	MATERIA PRIMA	TERMINADO	POTENCIA MÁX. (W)	VOLTAJE (RANGO)	VAC-Hz	TIPO DE SOCKET	No. DE SOCKET
C307/HU	LUMINARIA SUSPENDIDA PARA TECHO	INTERIOR	ACERO - CRISTAL	NEGRO Y HUMO	40 W	125 V~	50-60 Hz	E27	1
C351/HU	LUMINARIA SUSPENDIDA PARA TECHO	INTERIOR	ACERO - CRISTAL	NEGRO Y HUMO	40 W	125 V~	50-60 Hz	E27	1
C090/HU	LUMINARIA SUSPENDIDA PARA TECHO	INTERIOR	ACERO - CRISTAL	CROMO Y HUMO	40 W	125 V~	50-60 Hz	E27	1

PRODUCTO
NUEVO



C304/NE

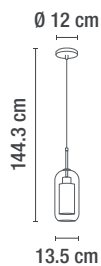

PRODUCTO
NUEVO



C305/HU

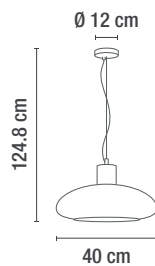

PRODUCTO
NUEVO



C306/CR

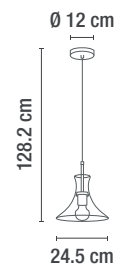

CÓDIGO	DESCRIPCIÓN	APLICACIÓN	MATERIA PRIMA	TERMINADO	POTENCIA MÁX. (W)	VOLTAJE (RANGO)	VAC-Hz	TIPO DE SOCKET	No. DE SOCKET
C304/NE	LUMINARIA SUSPENDIDA PARA TECHO	INTERIOR	ACERO - CRISTAL	NEGRO / HUMO	40 W	125 V~	50-60 Hz	E27	1
C305/HU	LUMINARIA SUSPENDIDA PARA TECHO	INTERIOR	ACERO - CRISTAL	NEGRO / HUMO	40 W	125 V~	50-60 Hz	E27	1
C306/CR	LUMINARIA SUSPENDIDA PARA TECHO	INTERIOR	ACERO - CRISTAL	NEGRO / TRANSPARENTE	40 W	125 V~	50-60 Hz	E27	1



C071/AB

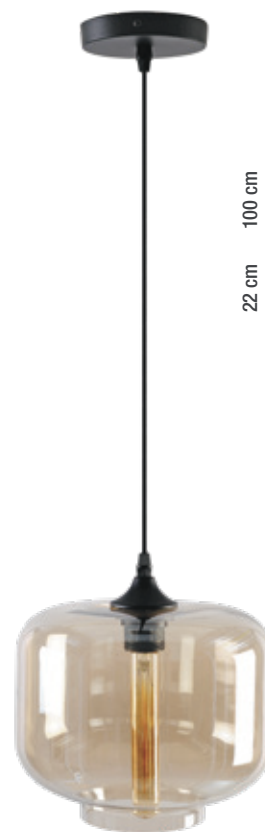
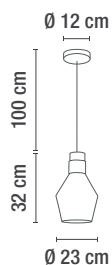

C070/AB

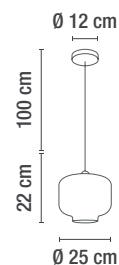

C072/AB

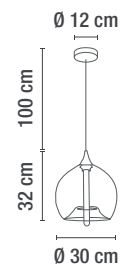

*ESTAS LUMINARIAS NO INCLUYEN LÁMPARAS

CÓDIGO	DESCRIPCIÓN	APLICACIÓN	MATERIA PRIMA	TERMINADO	POTENCIA MÁX. (W)	VOLTAJE (RANGO)	VAC-Hz	TIPO DE SOCKET	No. DE SOCKET
C071/AB	LUMINARIA SUSPENDIDA PARA TECHO	INTERIOR	ACERO - CRISTAL	ÁMBAR	40 W	125 V~	50-60 Hz	E27	1
C070/AB	LUMINARIA SUSPENDIDA PARA TECHO	INTERIOR	ACERO - CRISTAL	ÁMBAR	40 W	125 V~	50-60 Hz	E27	1
C072/AB	LUMINARIA SUSPENDIDA PARA TECHO	INTERIOR	ACERO - CRISTAL	ÁMBAR	40 W	125 V~	50-60 Hz	E27	1

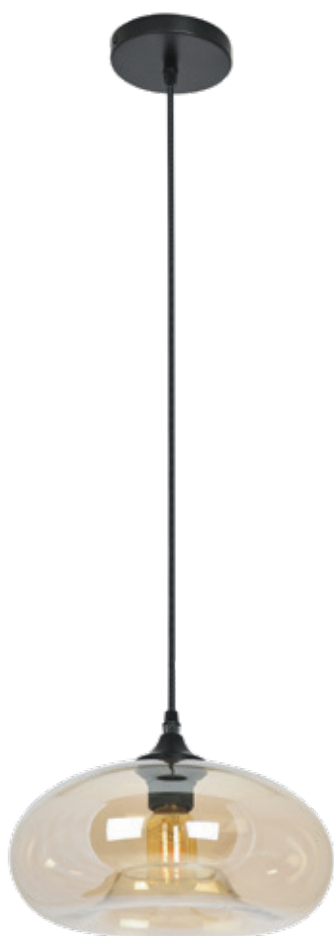

C003-E27/AB

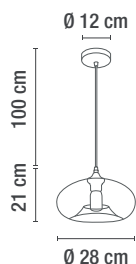

C117-E27/NE

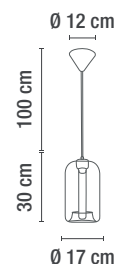

*ESTAS LUMINARIAS NO INCLUYEN LÁMPARAS

CÓDIGO	DESCRIPCIÓN	APLICACIÓN	MATERIA PRIMA	TERMINADO	POTENCIA MÁX. (W)	VOLTAJE (RANGO)	VAC-Hz	TIPO DE SOCKET	No. DE SOCKET
C003-E27/AB	LUMINARIA SUSPENDIDA PARA TECHO	INTERIOR	ACERO - CRISTAL	ÁMBAR	40 W	125 V~	50-60 Hz	E27	1
C117-E27/NE	LUMINARIA SUSPENDIDA PARA TECHO	INTERIOR	ACERO - CRISTAL	NEGRO / HUMO	40 W	125 V~	50-60 Hz	E27	1



C372/HU-3

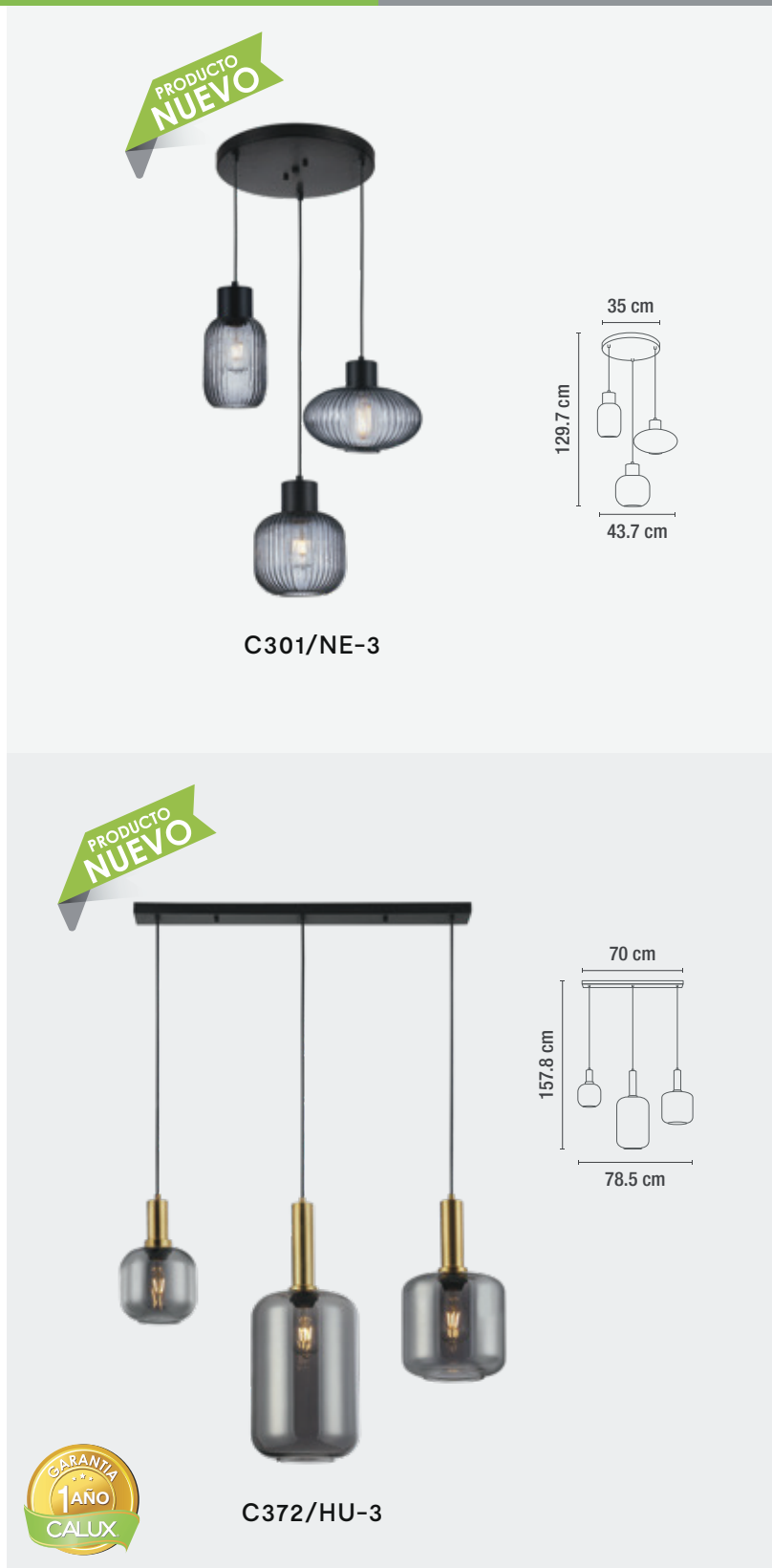

C301/NE-3

C372/HU-3

CÓDIGO	DESCRIPCIÓN	APLICACIÓN	MATERIA PRIMA	TERMINADO	POTENCIA MÁX. (W)	VOLTAJE (RANGO)	VAC-Hz	TIPO DE SOCKET	No. DE SOCKET
C301/NE-3	LUMINARIA SUSPENDIDA PARA TECHO	INTERIOR	ACERO - CRISTAL	NEGRO Y HUMO	120 W	125 V~	50-60 Hz	E27	3
C372/HU-3	LUMINARIA SUSPENDIDA PARA TECHO	INTERIOR	ACERO - CRISTAL	NEGRO, BRONCE Y HUMO	120 W	125 V~	50-60 Hz	E27	3

PRODUCTO
NUEVO

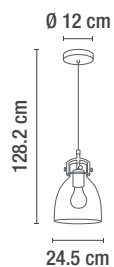

C370/NE

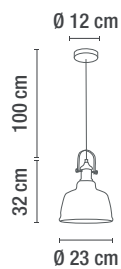

C091/AB



C091/AB

CÓDIGO	DESCRIPCIÓN	APLICACIÓN	MATERIA PRIMA	TERMINADO	POTENCIA MÁX. (W)	VOLTAJE (RANGO)	VAC-Hz	TIPO DE SOCKET	No. DE SOCKET
C370/NE	LUMINARIA SUSPENDIDA PARA TECHO	INTERIOR	ACERO - CRISTAL	NEGRO	40 W	125 V~	50-60 Hz	E27	1
C091/AB	LUMINARIA SUSPENDIDA PARA TECHO	INTERIOR	ACERO - CRISTAL	ÁMBAR Y LATÓN	40 W	125 V~	50-60 Hz	E27	1



C309/HU-3

PRODUCTO NUEVO

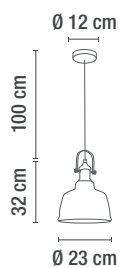

C091/HU

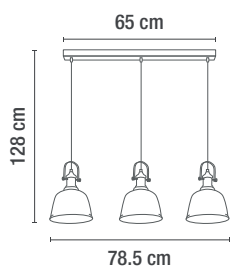

C309/HU-3



CÓDIGO	DESCRIPCIÓN	APLICACIÓN	MATERIA PRIMA	TERMINADO	POTENCIA MÁX. (W)	VOLTAJE (RANGO)	VAC-Hz	TIPO DE SOCKET	No. DE SOCKET
C091/HU	LUMINARIA SUSPENDIDA PARA TECHO	INTERIOR	ACERO - CRISTAL	HUMO Y LATÓN	40 W	125 V~	50-60 Hz	E27	1
C309/HU-3	LUMINARIA SUSPENDIDA PARA TECHO	INTERIOR	ACERO - CRISTAL	HUMO Y LATÓN	120 W	125 V~	50-60 Hz	E27	3

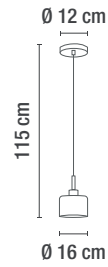

C096/CR

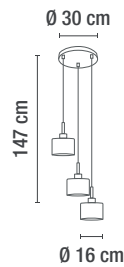

C096-3/CR



C096-3/CR

CÓDIGO	DESCRIPCIÓN	APLICACIÓN	MATERIA PRIMA	TERMINADO	POTENCIA MÁX. (W)	VOLTAJE (RANGO)	VAC-Hz	TIPO DE SOCKET	No. DE SOCKET
C096/CR	LUMINARIA SUSPENDIDA PARA TECHO	INTERIOR	ACERO - CRISTAL	CROMO	40 W	125 V~	50-60 Hz	E27	1
C096-3/CR	LUMINARIA SUSPENDIDA PARA TECHO	INTERIOR	ACERO - CRISTAL	CROMO	120 W	125 V~	50-60 Hz	E27	3



C317/OR-3

PRODUCTO NUEVO



C315/OR

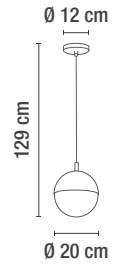

PRODUCTO NUEVO



C317/OR-3

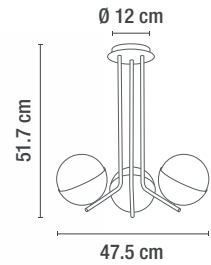

CÓDIGO	DESCRIPCIÓN	APLICACIÓN	MATERIA PRIMA	TERMINADO	POTENCIA MÁX. (W)	VOLTAJE (RANGO)	VAC-Hz	TIPO DE SOCKET	No. DE SOCKET
C315/OR	LUMINARIA SUSPENDIDA PARA TECHO	INTERIOR	ACERO - CRISTAL	LATÓN	40 W	125 V~	50-60 Hz	E27	1
C317/OR-3	LUMINARIA SUSPENDIDA PARA TECHO	INTERIOR	ACERO - CRISTAL	LATÓN	120 W	125 V~	50-60 Hz	E27	3



C098/HU

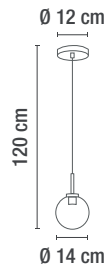

C098/CR

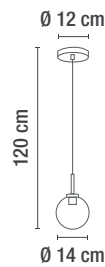

C098/CR



CÓDIGO	DESCRIPCIÓN	APLICACIÓN	MATERIA PRIMA	TERMINADO	POTENCIA MÁX. (W)	VOLTAJE (RANGO)	VAC-Hz	TIPO DE SOCKET	No. DE SOCKET
C098/HU C098/CR	LUMINARIA SUSPENDIDA PARA TECHO	INTERIOR	ACERO - CRISTAL	HUMO TRANSPARENTE	40 W	127 V~	50-60 Hz	E27	1

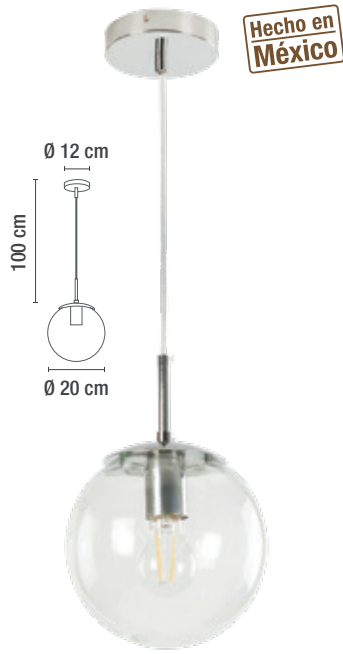

C108-R8/CR



C108-R8/NE



C108-R8/BL

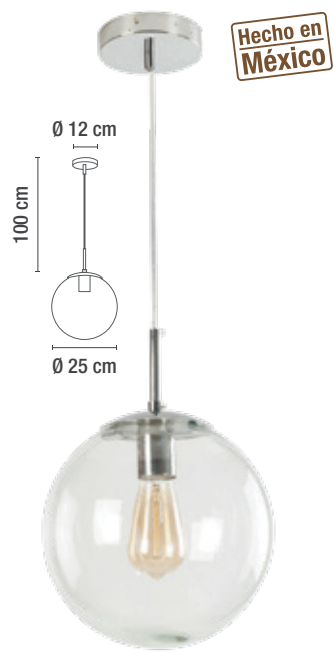

C110-R10/CR



C110-R10/NE



C110-R10/BL



*LÁMPARA NO INCLUIDA, VISITA NUESTRA SECCIÓN DE LÁMPARAS

CÓDIGO	DESCRIPCIÓN	APLICACIÓN	MATERIA PRIMA	TERMINADO	POTENCIA MÁX. (W)	VOLTAJE (RANGO)	VAC-Hz	TIPO DE SOCKET	No. DE SOCKET
C108-R8/CR C108-R8/NE C108-R8/BL	LUMINARIA SUSPENDIDA PARA TECHO	INTERIOR	ACERO - CRISTAL CRISTALINO	CROMO NEGRO BLANCO	40 W	127 V~	50-60 Hz	E27	1
C110-R10/CR C110-R10/NE C110-R10/BL	LUMINARIA SUSPENDIDA PARA TECHO	INTERIOR	ACERO - CRISTAL CRISTALINO	CROMO NEGRO BLANCO	40 W	127 V~	50-60 Hz	E27	1



C092/CR

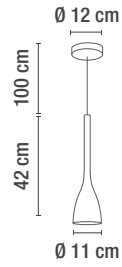

V2021

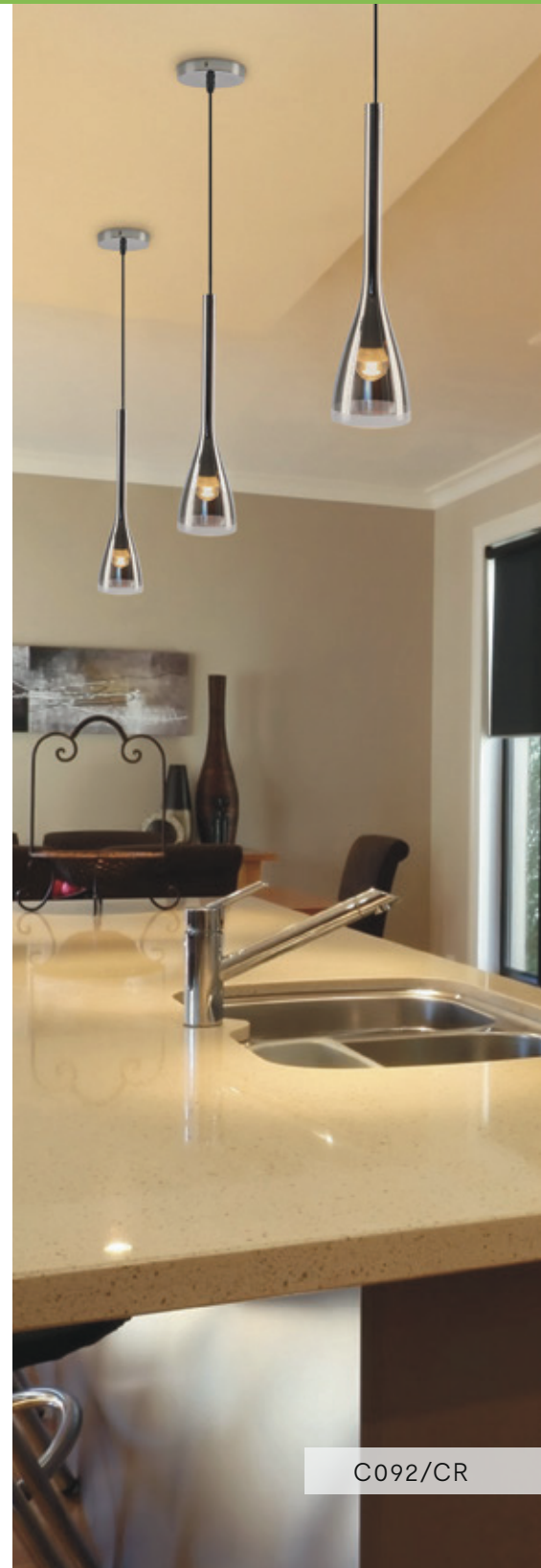
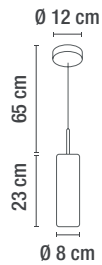

C092/CR

CÓDIGO	DESCRIPCIÓN	APLICACIÓN	MATERIA PRIMA	TERMINADO	POTENCIA MÁX. (W)	VOLTAJE (RANGO)	VAC-HZ	TIPO DE SOCKET	No. DE SOCKETS
C092/CR	LUMINARIA SUSPENDIDA PARA TECHO	INTERIOR	ACERO - CRISTAL	CROMO	25 W	127 V~	50-60 Hz	E27	1
V2021	LUMINARIA SUSPENDIDA PARA TECHO	INTERIOR	ACERO - CRISTAL	CROMO	50 W	127 V~	50-60 Hz	GU10	1



V2025

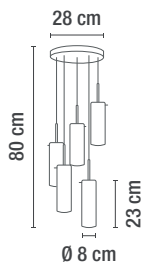

V2023

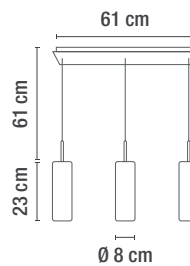

CÓDIGO	DESCRIPCIÓN	APLICACIÓN	MATERIA PRIMA	TERMINADO	POTENCIA MÁX. (W)	VOLTAJE (RANGO)	VAC-HZ	TIPO DE SOCKET	No. DE SOCKETS
V2023	LUMINARIA SUSPENDIDA PARA TECHO	INTERIOR	ACERO - CRISTAL	CROMO	150 W	127 V~	50-60 Hz	GU10	3
V2025	LUMINARIA SUSPENDIDA PARA TECHO	INTERIOR	ACERO - CRISTAL	CROMO	250 W	127 V~	50-60 Hz	GU10	5



C601/AM

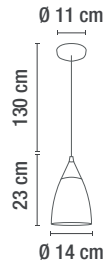

C3C601/AM

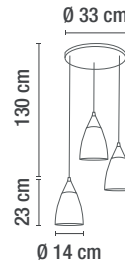

CÓDIGO	DESCRIPCIÓN	APLICACIÓN	MATERIA PRIMA	TERMINADO	POTENCIA MÁX. (W)	VOLTAJE (RANGO)	VAC-HZ	TIPO DE SOCKET	No. DE SOCKETS
C601/AM	LUMINARIA SUSPENDIDA PARA TECHO	INTERIOR	ALUMINIO - CRISTAL	ALUMINIO MATE/ CRISTAL ÁCIDO	60 W	127 V~	50-60 Hz	E27	1
C3C601/AM	LUMINARIA SUSPENDIDA PARA TECHO	INTERIOR	ALUMINIO - CRISTAL	ALUMINIO MATE/ CRISTAL ÁCIDO	180 W	127 V~	50-60 Hz	E27	3

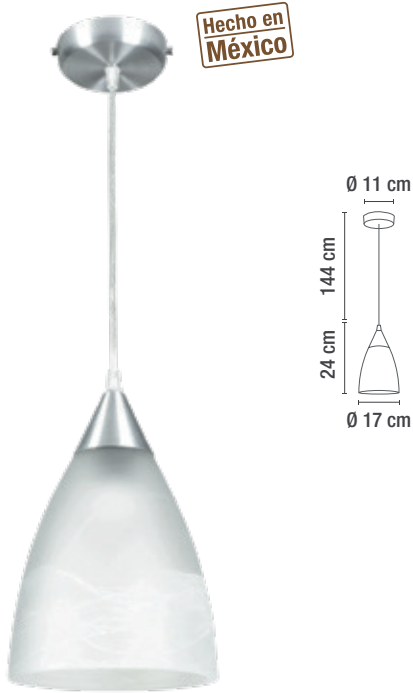

C701MB/AM

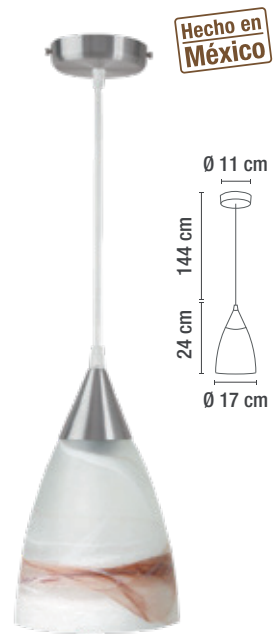

C701MC/AM

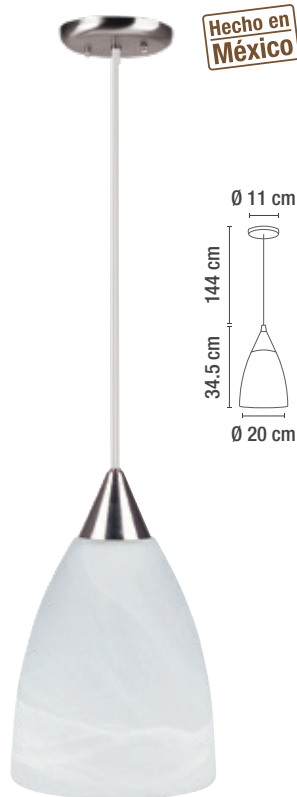

C901MB/AM



CÓDIGO	DESCRIPCIÓN	APLICACIÓN	MATERIA PRIMA	TERMINADO	POTENCIA MÁX. (W)	VOLTAJE (RANGO)	VAC-HZ	TIPO DE SOCKET	No. DE SOCKETS
C701MB/AM	LUMINARIA SUSPENDIDA PARA TECHO	INTERIOR	ALUMINIO - CRISTAL	ALUMINIO MATE CRISTAL MÁRMOL BLANCO	60 W	127 V~	50-60 Hz	E27	1
C701MC/AM	LUMINARIA SUSPENDIDA PARA TECHO	INTERIOR	ALUMINIO - CRISTAL	ALUMINIO MATE / CRISTAL MÁRMOL CAFÉ	60 W	127 V~	50-60 Hz	E27	1
C901MB/AM	LUMINARIA SUSPENDIDA PARA TECHO	INTERIOR	ALUMINIO - CRISTAL	ALUMINIO MATE CRISTAL MÁRMOL BLANCO	60 W	127 V~	50-60 Hz	E27	1

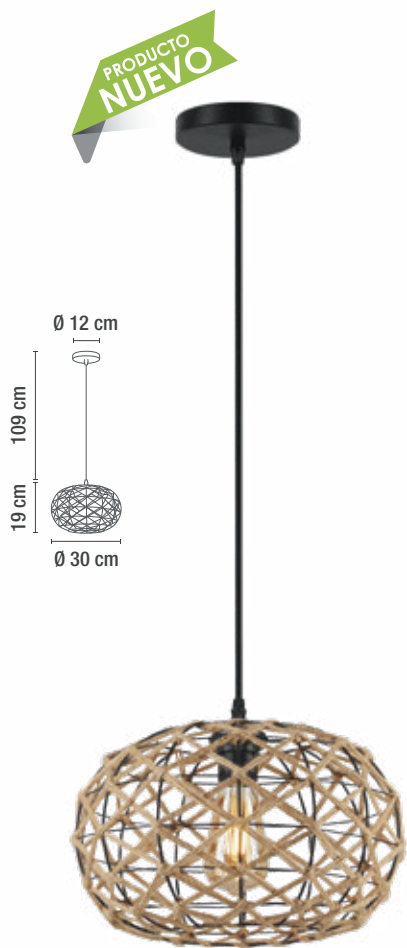

C365/BMB



C366/BMB



CÓDIGO	DESCRIPCIÓN	APLICACIÓN	MATERIA PRIMA	TERMINADO	POTENCIA MÁX. (W)	VOLTAJE (RANG)	VAC-HZ	TIPO DE SOCKET	No. DE SOCKETS
C365/BMB	LUMINARIA SUSPENDIDA PARA TECHO	INTERIOR	ACERO - FIBRA NATURAL	PAJA	40 W	127 V~	50-60 Hz	E27	1
C366/BMB	LUMINARIA SUSPENDIDA PARA TECHO	INTERIOR	ACERO - BAMBOO	PAJA	40 W	127 V~	50-60 Hz	E27	1



C368/BMB

PRODUCTO NUEVO

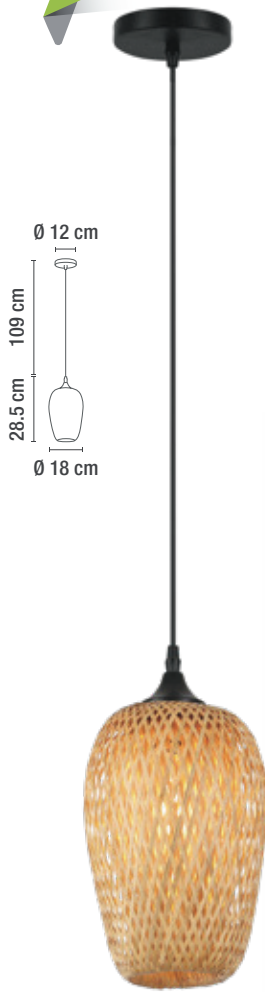

C367/BMB

PRODUCTO NUEVO

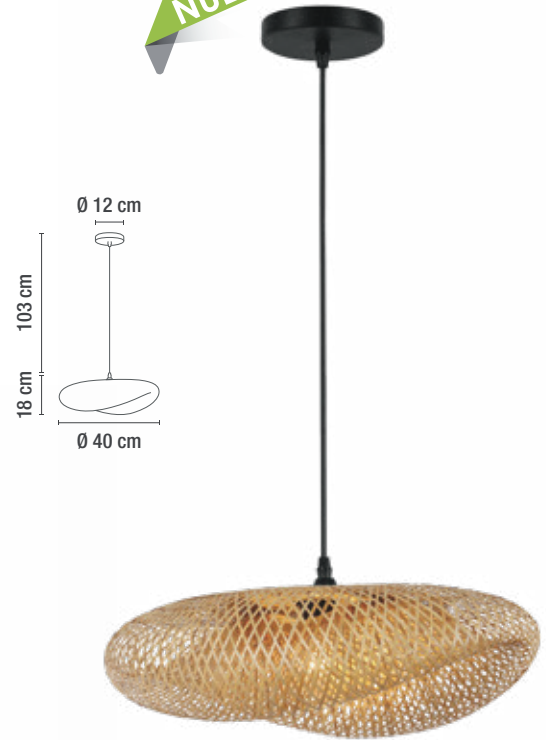

C368/BMB

PRODUCTO NUEVO

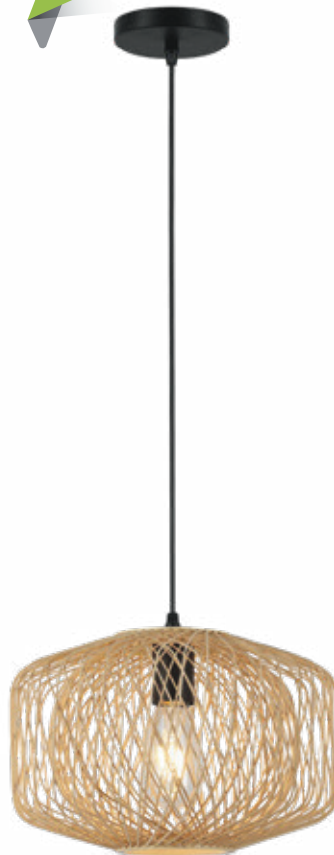

C369/BMB



CÓDIGO	DESCRIPCIÓN	APLICACIÓN	MATERIA PRIMA	TERMINADO	POTENCIA MÁX. (W)	VOLTAJE (RANGO)	VAC-HZ	TIPO DE SOCKET	No. DE SOCKETS
C367/BMB	LUMINARIA SUSPENDIDA PARA TECHO	INTERIOR	ACERO - BAMBOO	PAJA	40 W	125 V~	50-60 Hz	E27	1
C368/BMB	LUMINARIA SUSPENDIDA PARA TECHO	INTERIOR	ACERO - BAMBOO	PAJA	40 W	125 V~	50-60 Hz	E27	1
C369/BMB	LUMINARIA SUSPENDIDA PARA TECHO	INTERIOR	ACERO - BAMBOO	PAJA	40 W	125 V~	50-60 Hz	E27	1



4544

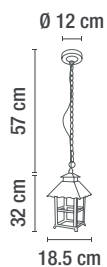

6504

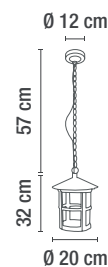

CÓDIGO	DESCRIPCIÓN	APLICACIÓN	MATERIA PRIMA	TERMINADO	POTENCIA MÁX. (W)	VOLTAJE (RANGO)	VAC-HZ	IP	TIPO DE SOCKET	No. DE SOCKETS
4544	LUMINARIA SUSPENDIDA PARA TECHO	EXTERIOR	ALUMINIO - CRISTAL	RÚSTICO	60 W	125 V~	50-60 Hz	54	E27	1
6504	LUMINARIA SUSPENDIDA PARA TECHO	EXTERIOR	ALUMINIO - CRISTAL	RÚSTICO	60 W	125 V~	50-60 Hz	54	E27	1



CFI5L/ONIX/O



Hecho en México

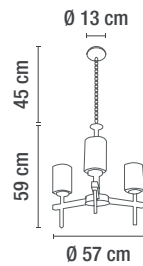

CCF023/ONIX



Hecho en México

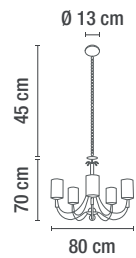

CFI5L/ONIX/O



CÓDIGO	DESCRIPCIÓN	APLICACIÓN	MATERIA PRIMA	TERMINADO	POTENCIA MÁX. (W)	VOLTAJE (RANGO)	VAC-HZ	TIPO DE SOCKET	No. DE SOCKETS
CCF023/ONIX	CANDIL SUSPENDIDO	INTERIOR	ACERO - ONIX NATURAL	CHOCOLATE	180 W	127 V~	50-60 Hz	E27	3
CFI5L/ONIX/O	CANDIL SUSPENDIDO	INTERIOR	ACERO FORJADO - ONIX NATURAL	ÓXIDO	300 W	127 V~	50-60 Hz	E27	5

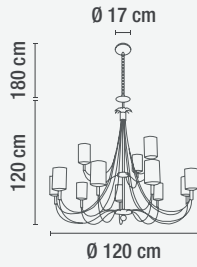

Hecho en México



CF112L/ONIX/O

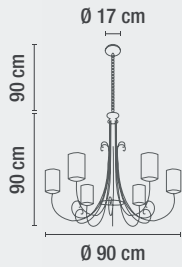

Hecho en México



CFW6L/ONIX/O

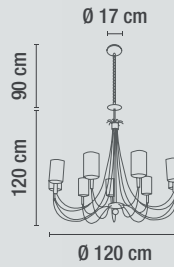

Hecho en México



CF19L/ONIX/O

CÓDIGO	DESCRIPCIÓN	APLICACIÓN	MATERIA PRIMA	TERMINADO	POTENCIA MÁX. (W)	VOLTAJE (RANGO)	VAC-HZ	TIPO DE SOCKET	No. DE SOCKETS
CF112L/ONIX/O	CANDIL SUSPENDIDO	INTERIOR	ACERO FORJADO - ONIX NATURAL	ÓXIDO	720 W	127 V~	50-60 Hz	E27	12
CFW6L/ONIX/O	CANDIL SUSPENDIDO	INTERIOR	ACERO FORJADO - ONIX	ÓXIDO	360 W	127 V~	50-60 Hz	E27	6
CF19L/ONIX/O	CANDIL SUSPENDIDO	INTERIOR	ACERO FORJADO - ONIX NATURAL	ÓXIDO	540 W	127 V~	50-60 Hz	E27	9

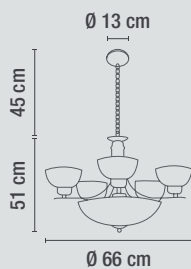

Hecho en México

CFCP6L/O

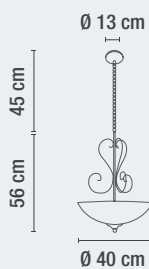

Hecho en México

CFS1261/O

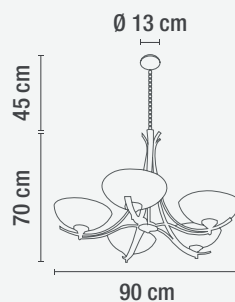

Hecho en México

CFD5L/CH



CÓDIGO	DESCRIPCIÓN	APLICACIÓN	MATERIA PRIMA	TERMINADO	POTENCIA MÁX. (W)	VOLTAJE (RANGO)	VAC-HZ	TIPO DE SOCKET	No. DE SOCKETS
CFCP6L/O	CANDIL SUSPENDIDO	INTERIOR	ACERO FORJADO - CRISTAL	ÓXIDO	420 W	125 V~	50-60 Hz	E27	7
CFS1261/O	CANDIL SUSPENDIDO	INTERIOR	ACERO FORJADO - CRISTAL	ÓXIDO	120 W	125 V~	50-60 Hz	E27	2
CFD5L/CH	CANDIL SUSPENDIDO	INTERIOR	ACERO FORJADO - CRISTAL	CHOCOLATE	300 W	125 V~	50-60 Hz	E27	5



CFT3LP/O

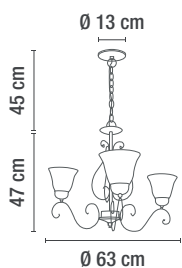

CFT6LP/O

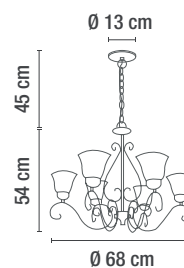

CÓDIGO	DESCRIPCIÓN	APLICACIÓN	MATERIA PRIMA	TERMINADO	POTENCIA MÁX. (W)	VOLTAJE (RANGO)	VAC-HZ	TIPO DE SOCKET	No. DE SOCKETS
CFT3LP/O	CANDIL SUSPENDIDO	INTERIOR	ACERO FORJADO - CRISTAL	ÓXIDO	180 W	127 V~	50-60 Hz	E27	3
CFT6LP/O	CANDIL SUSPENDIDO	INTERIOR	ACERO FORJADO - CRISTAL	ÓXIDO	360 W	127 V~	50-60 Hz	E27	6

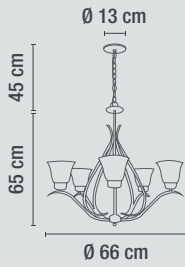

Hecho en México



CFK5L/O

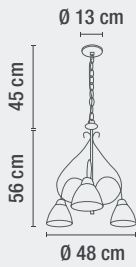

Hecho en México



CFM3L/O

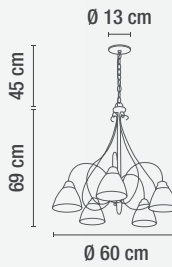

Hecho en México



CFM5L/O



CÓDIGO	DESCRIPCIÓN	APLICACIÓN	MATERIA PRIMA	TERMINADO	POTENCIA MÁX. (W)	VOLTAJE (RANGO)	VAC-HZ	TIPO DE SOCKET	No. DE SOCKETS
CFK5L/O	CANDIL SUSPENDIDO	INTERIOR	ACERO FORJADO - CRISTAL	ÓXIDO	300 W	127 V~	50-60 Hz	E27	5
CFM3L/O	CANDIL SUSPENDIDO	INTERIOR	ACERO FORJADO - CRISTAL	ÓXIDO	180 W	127 V~	50-60 Hz	E27	3
CFM5L/O	CANDIL SUSPENDIDO	INTERIOR	ACERO FORJADO - CRISTAL	ÓXIDO	300 W	127 V~	50-60 Hz	E27	5



C2025-5/CO



C2027-3/CO



C2025-5/CO

CÓDIGO	DESCRIPCIÓN	APLICACIÓN	MATERIA PRIMA	TERMINADO	POTENCIA MÁX. (W)	VOLTAJE (RANGO)	VAC-HZ	TIPO DE SOCKET	No. DE SOCKETS
C2027-3/CO	CANDIL SUSPENDIDO	INTERIOR	ALUMINIO - CRISTAL	CAFÉ OBSCURO	180 W	127 V~	50-60 Hz	E27	3
C2025-5/CO	CANDIL SUSPENDIDO	INTERIOR	ALUMINIO - CRISTAL	CAFÉ OBSCURO	300 W	127 V~	50-60 Hz	E27	5

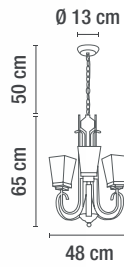

C1083-3

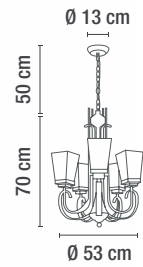

C1084-5

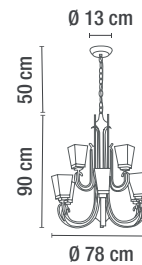

C1086-3+6



CÓDIGO	DESCRIPCIÓN	APLICACIÓN	MATERIA PRIMA	TERMINADO	POTENCIA MÁX. (W)	VOLTAJE (RANGO)	VAC-HZ	TIPO DE SOCKET	No. DE SOCKETS
C1083-3	CANDIL SUSPENDIDO	INTERIOR	ACERO FORJADO - CRISTAL ÁMBAR	VERDE ANTIGUO	180 W	127 V~	50-60 Hz	E27	3
C1084-5	CANDIL SUSPENDIDO	INTERIOR	ACERO FORJADO - CRISTAL ÁMBAR	VERDE ANTIGUO	300 W	127 V~	50-60 Hz	E27	5
C1086-3+6	CANDIL SUSPENDIDO	INTERIOR	ACERO FORJADO - CRISTAL ÁMBAR	VERDE ANTIGUO	540 W	127 V~	50-60 Hz	E27	9

Hecho en México



CIT3L/S

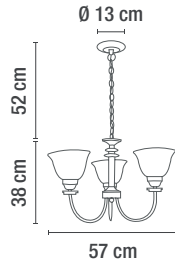

C2025-5/S

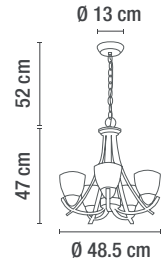

C2027-3/S

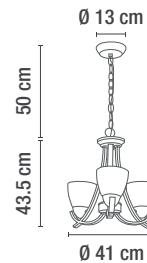

CÓDIGO	DESCRIPCIÓN	APLICACIÓN	MATERIA PRIMA	TERMINADO	POTENCIA MÁX. (W)	VOLTAJE (RANGO)	VAC-HZ	TIPO DE SOCKET	No. DE SOCKETS
CIT3L/S	CANDIL SUSPENDIDO	INTERIOR	ACERO - CRISTAL	SATINADO	180 W	127 V~	50-60 Hz	E27	3
C2025-5/S	CANDIL SUSPENDIDO	INTERIOR	ACERO - CRISTAL	SATINADO	300 W	127 V~	50-60 Hz	E27	5
C2027-3/S	CANDIL SUSPENDIDO	INTERIOR	ACERO - CRISTAL	SATINADO	180 W	127 V~	50-60 Hz	E27	3

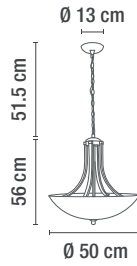

2531-3

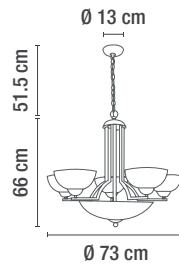

94938-5+3



2531-3

CÓDIGO	DESCRIPCIÓN	APLICACIÓN	MATERIA PRIMA	TERMINADO	POTENCIA MÁX. (W)	VOLTAJE (RANGO)	VAC-HZ	TIPO DE SOCKET	No. DE SOCKETS
2531-3	CANDIL SUSPENDIDO	INTERIOR	ALUMINIO - CRISTAL	SATINADO	180 W	127 V~	50-60 Hz	E27	3
94938-5+3	CANDIL SUSPENDIDO	INTERIOR	ALUMINIO - CRISTAL	SATINADO	480 W	127 V~	50-60 Hz	E27	8

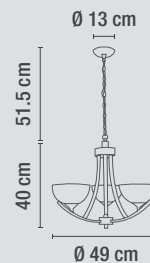

96233-3

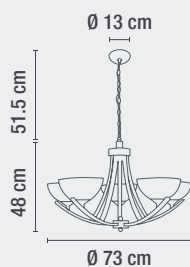

96235-5

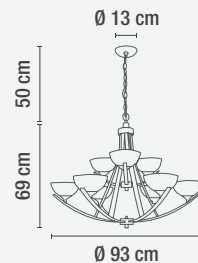

96239-3+6



CÓDIGO	DESCRIPCIÓN	APLICACIÓN	MATERIA PRIMA	TERMINADO	POTENCIA MÁX. (W)	VOLTAJE (RANGO)	VAC-HZ	TIPO DE SOCKET	No. DE SOCKETS
96233-3	CANDIL SUSPENDIDO	INTERIOR	ACERO - CRISTAL	SATINADO	180 W	127 V~	50-60 Hz	E27	3
96235-5	CANDIL SUSPENDIDO	INTERIOR	ACERO - CRISTAL	SATINADO	300 W	127 V~	50-60 Hz	E27	5
96239-3+6	CANDIL SUSPENDIDO	INTERIOR	ACERO - CRISTAL	SATINADO	540 W	127 V~	50-60 Hz	E27	9



Hecho en México

P145/CH

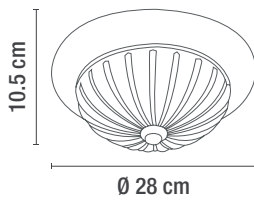

Hecho en México

P185/CH

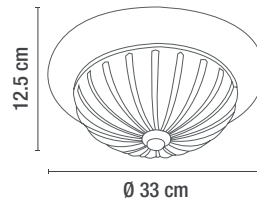

Hecho en México

P611/CH

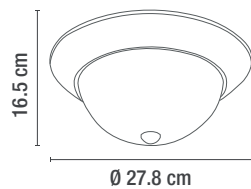

Hecho en México

P811/CH

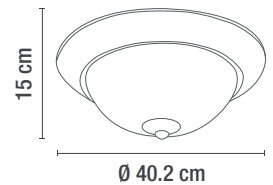

CÓDIGO	DESCRIPCIÓN	APLICACIÓN	MATERIA PRIMA	TERMINADO	POTENCIA MÁX. (W)	VOLTAJE (RANGO)	VAC-HZ	TIPO DE SOCKET	No. DE SOCKETS
P145/CH	PLAFÓN DE SOBREPONER EN TECHO	INTERIOR	ACERO - CRISTAL	CHOCOLATE	80 W	127 V~	50-60 Hz	E27	2
P185/CH	PLAFÓN DE SOBREPONER EN TECHO	INTERIOR	ACERO - CRISTAL	CHOCOLATE	80 W	127 V~	50-60 Hz	E27	2
P611/CH	PLAFÓN DE SOBREPONER EN TECHO	INTERIOR	ACERO - CRISTAL	CHOCOLATE	80 W	127 V~	50-60 Hz	E27	2
P811/CH	PLAFÓN DE SOBREPONER EN TECHO	INTERIOR	ACERO - CRISTAL	CHOCOLATE	120 W	127 V~	50-60 Hz	E27	2



JB11-9

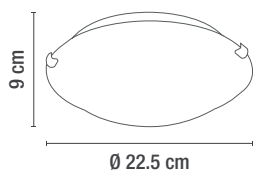

JB11-16

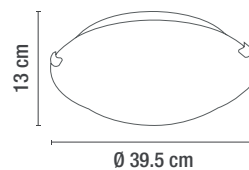

JB11-12

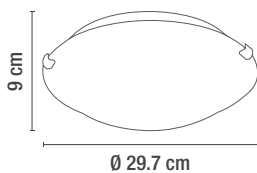

CÓDIGO	DESCRIPCIÓN	APLICACIÓN	MATERIA PRIMA	TERMINADO	POTENCIA MÁX. (W)	VOLTAJE (RANGO)	VAC-HZ	TIPO DE SOCKET	No. DE SOCKETS
JB11-9	PLAFÓN DE SOBREPONER EN TECHO	INTERIOR	ACERO - CRISTAL	ÁCIDO	60 W	127 V~	50-60 Hz	E27	1
JB11-12	PLAFÓN DE SOBREPONER EN TECHO	INTERIOR	ACERO - CRISTAL	ÁCIDO	60 W	127 V~	50-60 Hz	E27	1
JB11-16	PLAFÓN DE SOBREPONER EN TECHO	INTERIOR	ACERO - CRISTAL	ÁCIDO	120 W	127 V~	50-60 Hz	E27	2



BL24

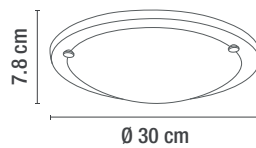

BL24-CH

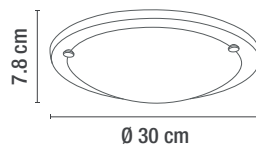

CÓDIGO	DESCRIPCIÓN	APLICACIÓN	MATERIA PRIMA	TERMINADO	POTENCIA MÁX. (W)	VOLTAJE (RANGO)	VAC-HZ	TIPO DE SOCKET	No. DE SOCKETS
BL24 BL24-CH	PLAFÓN DE SOBREPONER EN TECHO	INTERIOR	ACERO - CRISTAL	SATINADO CHOCOLATE	60 W	127 V~	50-60 Hz	E27	1

Hecho en México



N450B

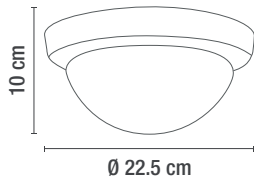

NE950/B

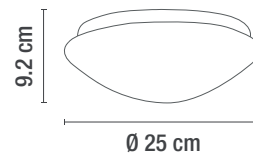

AE714/B

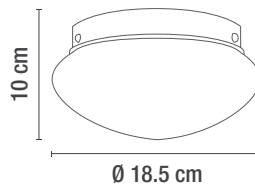

CÓDIGO	DESCRIPCIÓN	APLICACIÓN	MATERIA PRIMA	TERMINADO	POTENCIA MÁX. (W)	VOLTAJE (RANGO)	VAC-HZ	TIPO DE SOCKET	No. DE SOCKETS
N450B	PLAFÓN DE SOBREPONER EN TECHO	INTERIOR	ACERO - CRISTAL/OPALINO	BLANCO	60 W	127 V~	50-60 Hz	E27	1
NE950/B	PLAFÓN DE SOBREPONER EN TECHO	INTERIOR	ACERO - CRISTAL OPALINO	BLANCO	120 W	127 V~	50-60 Hz	E27	2
AE714/B	PLAFÓN DE SOBREPONER EN TECHO	INTERIOR	ALUMINIO - CRISTAL OPALINO Ó PMMA	BLANCO	60 W	127 V~	50-60 Hz	E27	1



Hecho en México

BR6/B

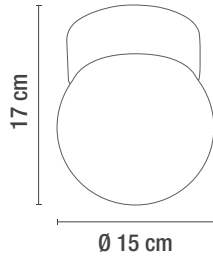

Hecho en México

BR6/N

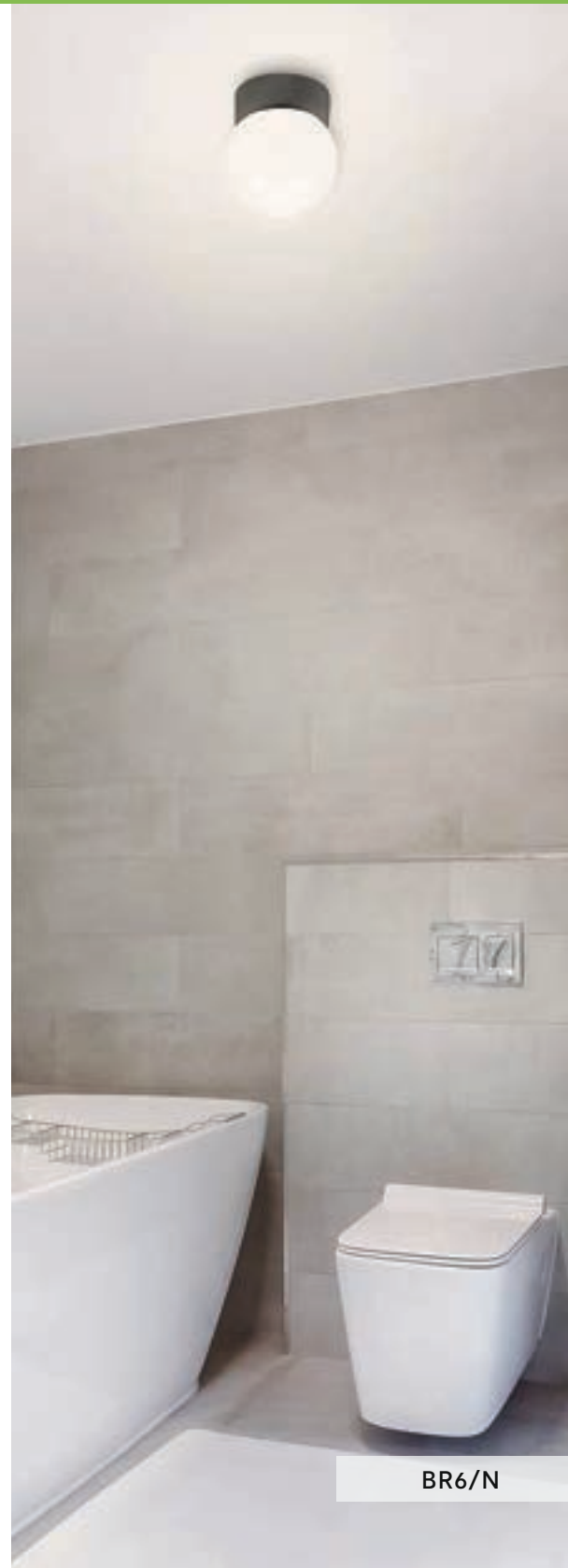
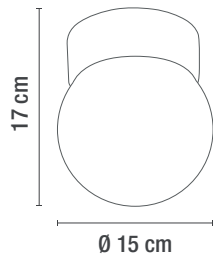

BR6/N



CÓDIGO	DESCRIPCIÓN	APLICACIÓN	MATERIA PRIMA	TERMINADO	POTENCIA MÁX. (W)	VOLTAJE (RANGO)	VAC-HZ	TIPO DE SOCKET	No. DE SOCKETS
BR6/B BR6/N	PLAFÓN DE SOBREPONER EN TECHO	INTERIOR	ACERO - CRISTAL OPALINO O PMMA	BLANCO NEGRO	60 W	127 V~	50-60 Hz	E27	1

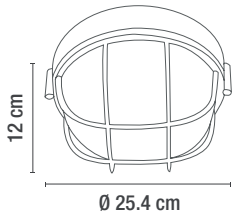

5001/B



5011/B

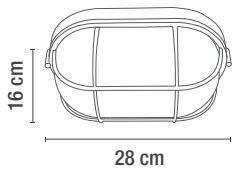
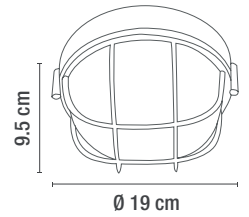

5021/N



5031/N

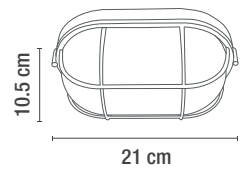

CÓDIGO	DESCRIPCIÓN	APLICACIÓN	MATERIA PRIMA	TERMINADO	POTENCIA MÁX. (W)	VOLTAJE (RANGO)	VAC-HZ	TIPO DE SOCKET	No. DE SOCKETS
5001/B 5001/N	LUMINARIA DE SOBREPONER EN TECHO	EXTERIOR	ALUMINIO - CRISTAL	BLANCO NEGRO	60 W	127 V~	50-60 Hz	E27	1
5011/B 5011/N	LUMINARIA DE SOBREPONER EN TECHO	EXTERIOR	ALUMINIO - CRISTAL	BLANCO NEGRO	60 W	127 V~	50-60 Hz	E27	1
5021/N 5021/B	LUMINARIA DE SOBREPONER EN TECHO	EXTERIOR	ALUMINIO - CRISTAL	NEGRO BLANCO	60 W	127 V~	50-60 Hz	E27	1
5031/N 5031/B	LUMINARIA DE SOBREPONER EN TECHO	EXTERIOR	ALUMINIO - CRISTAL	NEGRO BLANCO	60 W	127 V~	50-60 Hz	E27	1



3825F-LED/BL

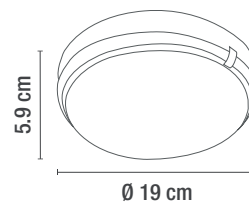

3826F-LED/BL



3827N-LED/BL

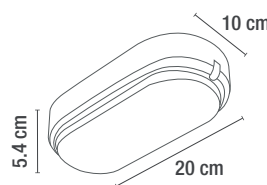
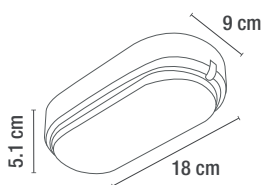

CÓDIGO	DESCRIPCIÓN	APLICACIÓN	MATERIA PRIMA	TERMINADO	POTENCIA MÁX. (W)	VOLTAJE (RANGO)	VAC-HZ	VIDA PROMEDIO (h)	ÁNGULO DE APERTURA	LUMENS	TEMPERATURA
3825F-LED/BL	LUMINARIA LED DE SOBREPONER EN TECHO	EXTERIOR	POLIPROPILENO	BLANCO	15 W	100-240 V~	50-60 Hz	25000 h	110°	1050 lm	6 500 K
3826F-LED/BL	LUMINARIA LED DE SOBREPONER EN TECHO	EXTERIOR	POLIPROPILENO	BLANCO	8 W	100-240 V~	50-60 Hz	25000 h	110°	560 lm	6 500 K
3827N-LED/BL	LUMINARIA LED DE SOBREPONER EN TECHO	EXTERIOR	POLIPROPILENO	BLANCO	15 W	100-240 V~	50-60 Hz	25000 h	110°	1050 lm	4 000 K

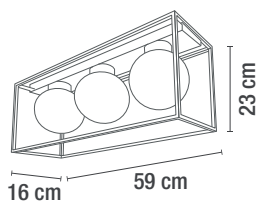

C2035-3/CR

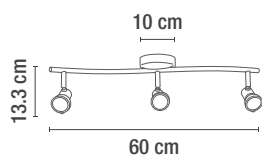

HS-5013-3



*ESTAS LUMINARIAS NO INCLUYEN LÁMPARAS

CÓDIGO	DESCRIPCIÓN	APLICACIÓN	MATERIA PRIMA	TERMINADO	POTENCIA MÁX. (W)	VOLTAJE (RANGO)	VAC-Hz	TIPO DE SOCKET	No. DE SOCKET
HS-5013-3	LUMINARIA DIRIGIBLE DE SOBREPONER EN TECHO	INTERIOR	ACERO	SATINADO	150 W	127 V~	50-60 Hz	GU10	3
C2035-3/CR	LUMINARIA DE SOBREPONER EN TECHO	INTERIOR	ACERO - CRISTAL	CROMO	120 W	125 V~	50-60 Hz	E27	3

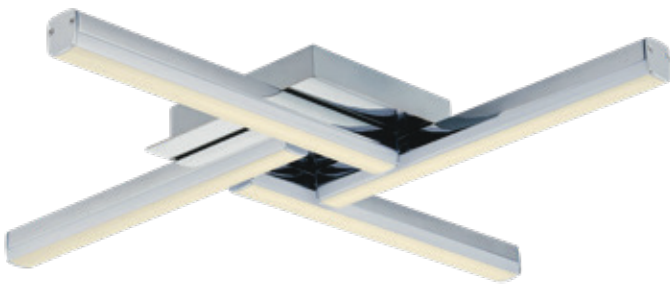

PL500-LED/CR

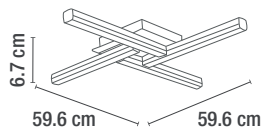

PL506-LED/NE

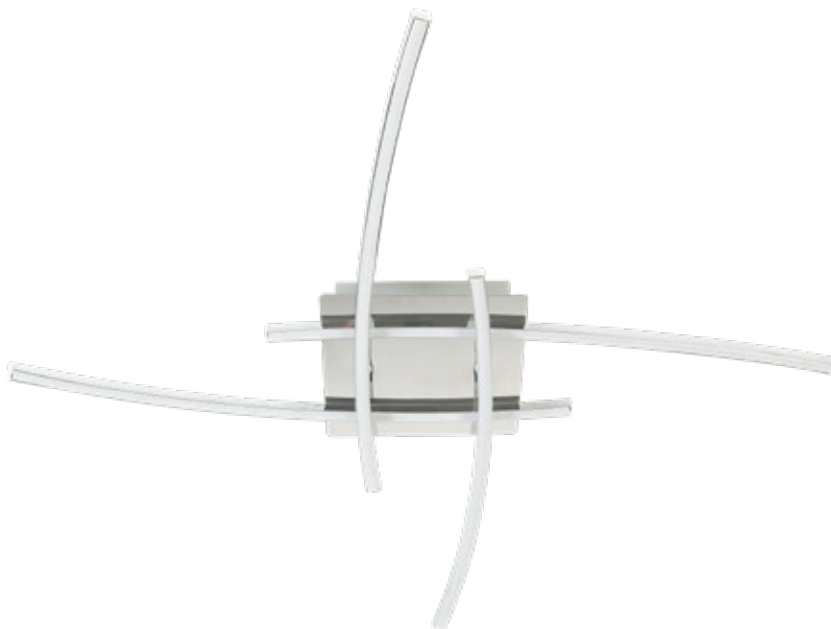
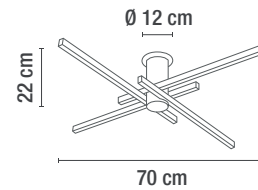

PL800-LED/CR

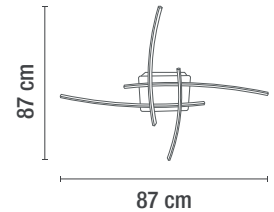

CÓDIGO	DESCRIPCIÓN	APLICACIÓN	MATERIA PRIMA	TERMINADO	POTENCIA MÁX. (W)	VOLTAJE (RANGO)	VAC-HZ	VIDA PROMEDIO (h)	ÁNGULO DE APERTURA	LUMENS	TEMPERATURA
PL500-LED/CR	LUMINARIA LED DE SOBREPONER EN TECHO	INTERIOR	ALUMINIO - POLICARBONATO	CROMO	22 W	100-240 V~	50-60 Hz	20000 h	110°	2440 lm	3 000 K
PL506-LED/NE	LUMINARIA LED DE SOBREPONER EN TECHO	INTERIOR	ALUMINIO /ACERO - POLICARBONATO	NEGRO MATE	35 W	100-240 V~	50-60 Hz	30000 h	180°	1 100 lm	3 000 K
PL800-LED/CR	LUMINARIA LED DE SOBREPONER EN TECHO	INTERIOR	ALUMINIO/ ACERO - POLICARBONATO	CROMO	28 W	100-240 V~	50-60 Hz	20000 h	180°	1960 lm	3 000 K



DLP096LED-C/BL

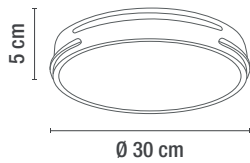

DLP096LED-F/NE

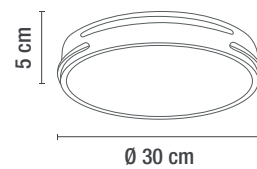

DLP098LED-F/BL

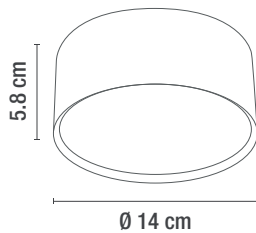

DLP098LED-F/NE

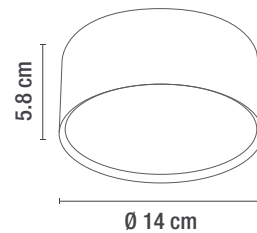

CÓDIGO	DESCRIPCIÓN	APLICACIÓN	MATERIA PRIMA	TERMINADO	POTENCIA MÁX. (W)	VOLTAJE (RANGO)	VAC-HZ	VIDA PROMEDIO (h)	ÁNGULO DE APERTURA	LUMENS	TEMPERATURA
DLP096LED-C/BL DLP096LED-F/NE	LUMINARIA LED DE SOBREPONER EN TECHO	INTERIOR	ACERO - POLICARBONATO	BLANCO NEGRO	20 W	100-240 V~	50-60 Hz	20000 h	180°	1475 lm	3 000 K 6 500 K
DLP098LED-F/BL DLP098LED-F/NE	LUMINARIA LED DE SOBREPONER EN TECHO	INTERIOR	ALUMINIO - POLICARBONATO	BLANCO NEGRO	18 W	100-240 V~	50-60 Hz	30000 h	110°	1440 lm	6 500 K



DLP032-12W/F

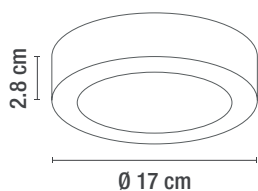

DLP036-18W/C

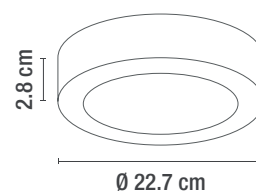

DLP035-12W/N

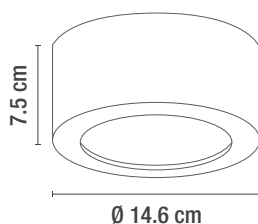

CÓDIGO	DESCRIPCIÓN	APLICACIÓN	MATERIA PRIMA	TERMINADO	POTENCIA MÁX. (W)	VOLTAJE (RANGO)	VAC-HZ	VIDA PROMEDIO (h)	ÁNGULO DE APERTURA	LUMENS	TEMPERATURA
DLP032-12W/F	LUMINARIA LED DE SOBREPONER EN TECHO	INTERIOR	ALUMINIO - POLIPROPILENO	BLANCO	12 W	100-240 V~	50-60 Hz	10.000 h	110°	480 lm	6 500 K
DLP036-18W/C DLP036-18W/F	LUMINARIA LED DE SOBREPONER EN TECHO	INTERIOR	ALUMINIO - POLIPROPILENO	BLANCO	18 W	100-240 V~	50-60 Hz	10.000 h	110°	810 lm	3 000K 6 500 K
DLP035-12W/N	LUMINARIA LED DE SOBREPONER EN TECHO	INTERIOR	ALUMINIO - ALUMINIO	BLANCO	12 W	100-240 V~	50-60 Hz	30000 h	130°	660 lm	4 100 K



DLP040-12W/C

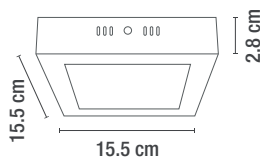

DLP042-18W/C

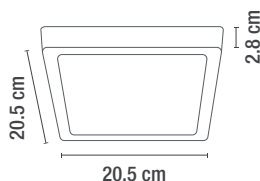

CÓDIGO	DESCRIPCIÓN	APLICACIÓN	MATERIA PRIMA	TERMINADO	POTENCIA MÁX. (W)	VOLTAJE (RANGO)	VAC-HZ	VIDA PROMEDIO (h)	ÁNGULO DE APERTURA	LUMENS	TEMPERATURA
DLP040-12W/C DLP040-12W/F	LUMINARIA LED DE SOBREPONER EN TECHO	INTERIOR	ALUMINIO - POLIPROPILENO	BLANCO	12 W	100-240 V~	50-60 Hz	10.000 h	110°	480 lm	3 000K 6 500 K
DLP042-18W/C DLP042-18W/F	LUMINARIA LED DE SOBREPONER EN TECHO	INTERIOR	ALUMINIO - POLIPROPILENO	BLANCO	18 W	100-240 V~	50-60 Hz	10.000 h	110°	810 lm	3 000K 6 500 K

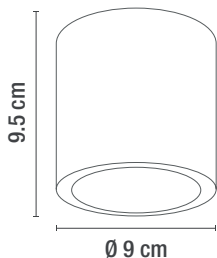

7920-LED

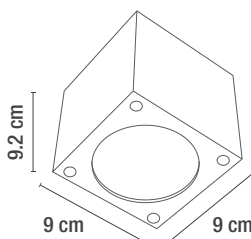

7720-LED



7920-LED

CÓDIGO	DESCRIPCIÓN	APLICACIÓN	MATERIA PRIMA	TERMINADO	POTENCIA MÁX. (W)	VOLTAJE (RANGO)	VAC-HZ	VIDA PROMEDIO (h)	ÁNGULO DE APERTURA	LUMENS	TEMPERATURA
7920-LED	LUMINARIA LED DE SOBREPONER EN TECHO	EXTERIOR	ALUMINIO - CRISTAL	GRAFITO	7 W	100-240 V~	50-60 Hz	30000 h	17°	581 lm	3 000 K
7720-LED	LUMINARIA LED DE SOBREPONER EN TECHO	EXTERIOR	ALUMINIO - CRISTAL	GRAFITO	7 W	100-240 V~	50-60 Hz	30000 h	19°	581 lm	3 000 K

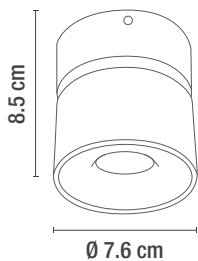

TD7931LED-C/BL

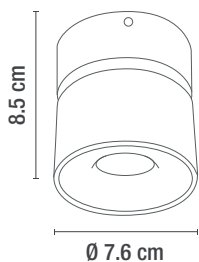

TD7933LED-C/NE



CÓDIGO	DESCRIPCIÓN	APLICACIÓN	MATERIA PRIMA	TERMINADO	POTENCIA MÁX. (W)	VOLTAJE (RANGO)	VAC-HZ
TD7931LED-C/BL TD7933LED-C/NE	LUMINARIA LED DE SOBREPONER EN TECHO	INTERIOR	ALUMINIO - POLICARBONATO	BLANCO NEGRO	8 W	100-240 V~	50-60 Hz



7615-GU10/BL

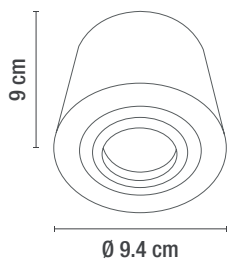

7635-GU10/GF

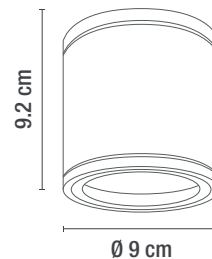

7640-GU10/GF

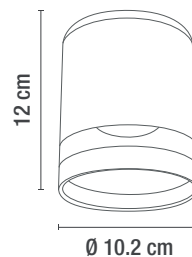

CÓDIGO	DESCRIPCIÓN	APLICACIÓN	MATERIA PRIMA	TERMINADO	POTENCIA MÁX. (W)	VOLTAJE (RANGO)	VAC-HZ	TIPO DE SOCKET	No. DE SOCKETS
7615-GU10/BL	LUMINARIA DE SOBREPONER EN TECHO	INTERIOR	ALUMINIO	BLANCO	50 W	127 V~	50-60 Hz	GU10	1
7635-GU10/GF	LUMINARIA DE SOBREPONER EN TECHO	EXTERIOR	ALUMINIO - CRISTAL	GRAFITO	35 W	100-240 V~	50-60 Hz	GU10	1
7640-GU10/GF	LUMINARIA DE SOBREPONER EN TECHO	EXTERIOR	ALUMINIO - POLICARBONATO	GRAFITO	6 W	100-240 V~	50-60 Hz	GU10	1



DLS010-6W/N

DLS010-6W/F

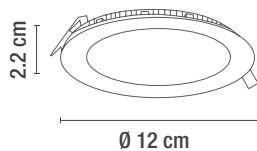

DLS011-9W/F

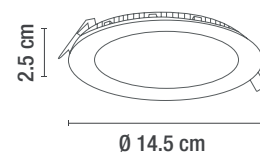

DLS012-12W/F

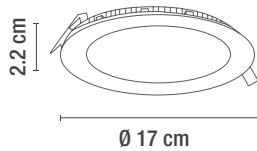

DLS014-18W/F

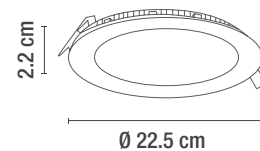

CÓDIGO	DESCRIPCIÓN	APLICACIÓN	MATERIA PRIMA	TERMINADO	POTENCIA MÁX. (W)	VOLTAJE (RANGO)	VAC-HZ	VIDA PROMEDIO (h)	ÁNGULO DE APERTURA	LUMENS	IRC	TEMPERATURA	CORTE DE EMPOTRAMIENTO
DLS010-6W/N DLS010-6W/F	LUMINARIA LED PARA EMPOTRAR EN TECHO	INTERIOR	ALUMINIO - POLICARBONATO	BLANCO	6 W	100-240 V~	50-60 Hz	50.000 h	107°	390 lm	70	4 100 K 6500 K	Ø 10.5 cm
DLS011-9W/F DLS011-9W/N	LUMINARIA LED PARA EMPOTRAR EN TECHO	INTERIOR	ALUMINIO - POLICARBONATO	BLANCO	9 W	100-240 V~	50-60 Hz	25000 h	110°	380 lm	70	6 500 K 4 100 K	Ø 12.6 cm
DLS012-12W/F DLS012-12W/N	LUMINARIA LED PARA EMPOTRAR EN TECHO	INTERIOR	ALUMINIO - POLICARBONATO	BLANCO	12 W	100-240 V~	50-60 Hz	50.000 h	107°	860 lm	70	6500 K 4 100 K	Ø 15.1 cm
DLS014-18W/F	LUMINARIA LED PARA EMPOTRAR EN TECHO	INTERIOR	ALUMINIO - POLICARBONATO	BLANCO	18 W	100-240 V~	50-60 Hz	50.000 h	98°	1600 lm	70	6500 K	Ø 20 cm



DLA026-9W/C

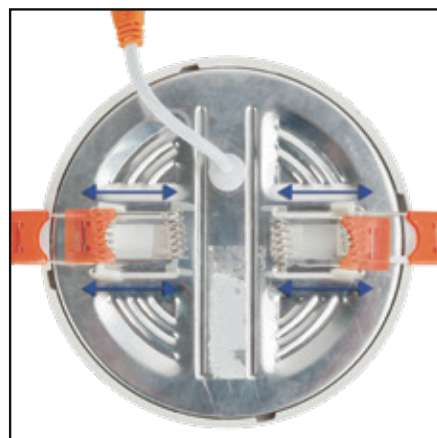

MONTAJE AJUSTABLE

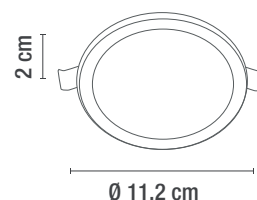

DLA030-16W/C

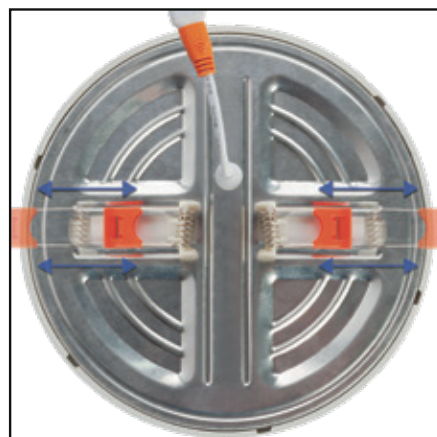

MONTAJE AJUSTABLE

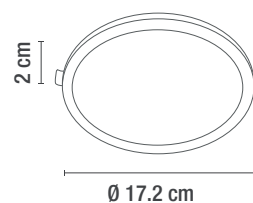

CÓDIGO	DESCRIPCIÓN	APLICACIÓN	MATERIA PRIMA	TERMINADO	POTENCIA MÁX. (W)	VOLTAJE (RANGO)	VAC-HZ	VIDA PROMEDIO (h)	ÁNGULO DE APERTURA	LUMENS	IRC	TEMPERATURA	CORTE DE EMPOTRAMIENTO
DLA026-9W/C DLA026-9W/F	LUMINARIA LED PARA EMPOTRAR EN TECHO	INTERIOR	ALUMINIO/PS-CRISTAL	BLANCO	9 W	100-240 V~	50-60 Hz	25000	110°	360 lm	70	3 000 K 6 500 K	Ø 5.0-8.0 cm
DLA030-16W/C DLA030-16W/F	LUMINARIA LED PARA EMPOTRAR EN TECHO	INTERIOR	ALUMINIO/PS-CRISTAL	BLANCO	16 W	100-240 V~	50-60 Hz	25000	110°	750 lm	70	3 000 K 6 500 K	Ø 5.0-13.0 cm



DL012-12W/C

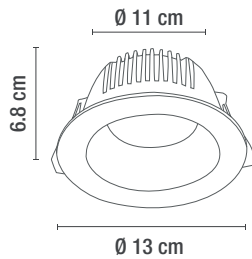

DL008-12W/F

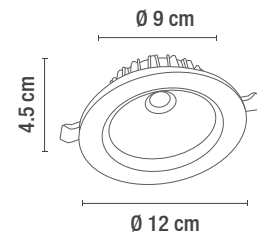

DL006-6.5W/C

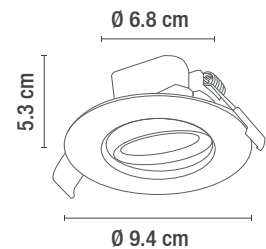

CÓDIGO	DESCRIPCIÓN	APLICACIÓN	MATERIA PRIMA	TERMINADO	POTENCIA MÁX. (W)	VOLTAJE (RANGO)	VAC-HZ	VIDA PROMEDIO (h)	ÁNGULO DE APERTURA	LUMENS	IRC	TEMPERATURA	CORTE DE EMPOTRAMIENTO
DL012-12W/C DL012-12W/F	LUMINARIA LED PARA EMPOTRAR EN TECHO	INTERIOR	ALUMINIO - POLICARBONATO	BLANCO / GRIS	12 W	100-240 V~	50-60 Hz	50.000 h	80°	800 lm	80	3 000 K 6 500 K	Ø 11 cm
DL008-12W/F	LUMINARIA LED PARA EMPOTRAR EN TECHO	INTERIOR	ALUMINIO - CRISTAL	BLANCO	12 W	100-240 V~	50-60 Hz	30000 h	35°	1020 lm	80	6 500 K	Ø 9 cm
DL006-6.5W/C DL006-6.5W/F	LUMINARIA LED DIRIGIBLE PARA EMPOTRAR EN TECHO	INTERIOR	PLÁSTICO (PBT) - POLICARBONATO	BLANCO	6.5 W	110-240 V~	50-60 Hz	15000 h	38°	500 lm	80	3 000 K 6 500 K	Ø 6.8 cm



DL007-18W/N

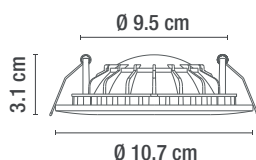

DL007-8W/N

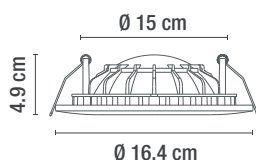

CÓDIGO	DESCRIPCIÓN	APLICACIÓN	MATERIA PRIMA	TERMINADO	POTENCIA MÁX. (W)	VOLTAJE (RANGO)	VAC-HZ	VIDA PROMEDIO (h)	ÁNGULO DE APERTURA	LUMENS	IRC	TEMPERATURA	CORTE DE EMPOTRAMIENTO
DL007-18W/N	LUMINARIA LED PARA EMPOTRAR EN TECHO	INTERIOR	ALUMINIO	BLANCO	18 W	100-240 V~	50-60 Hz	30000 h	130°	900 lm	80	4 100 K	Ø 15 cm
DL007-8W/N	LUMINARIA LED PARA EMPOTRAR EN TECHO	INTERIOR	ALUMINIO	BLANCO	8 W	100-240 V~	50-60 Hz	30000 h	130°	330 lm	80	4 100 K	Ø 9.5 cm



EM5080C-E27/B

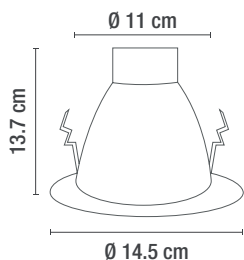

EM2010C-GU10/S

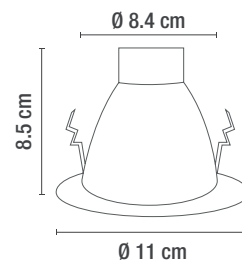

EM2020C-E27/B

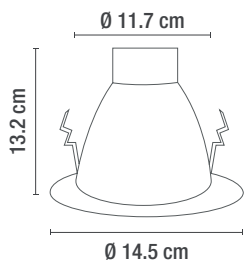

EM2020-E27/B

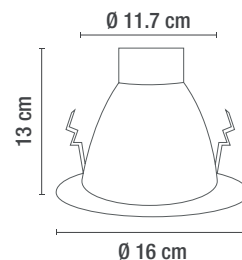

CÓDIGO	DESCRIPCIÓN	APLICACIÓN	MATERIA PRIMA	TERMINADO	POTENCIA MÁX. (W)	VOLTAJE (RANGO)	VAC-HZ	CORTE DE EMPOTRAMIENTO	TIPO DE SOCKET	No. DE SOCKETS
EM5080C-E27/B EM5080C-E27/S	LUMINARIA PARA EMPOTRAR EN TECHO	INTERIOR	ACERO - ALUMINIO - CRISTAL	BLANCO	60 W	127 V~	50-60 Hz	Ø 11.2 cm	E27	1
EM2010C-GU10/S	LUMINARIA PARA EMPOTRAR EN TECHO	INTERIOR	ACERO - ALUMINIO - CRISTAL	SATÍN	50 W	127 V~	50-60 Hz	Ø 8.5 cm	GU10	1
EM2020C-E27/B EM2020C-E27/S	LUMINARIA PARA EMPOTRAR EN TECHO	INTERIOR	ACERO - ALUMINIO - CRISTAL	BLANCO	60 W	127 V~	50-60 Hz	Ø 11.7 cm	E27	1
EM2020-E27/B	LUMINARIA PARA EMPOTRAR EN TECHO	INTERIOR	ACERO - ALUMINIO	BLANCO	60 W	127 V~	50-60 Hz	Ø 11.7 cm	E27	1



EM2015-E27/B

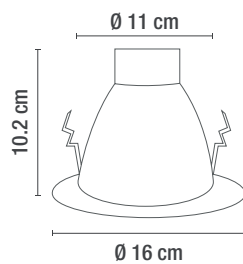

EM2015C-E27/S

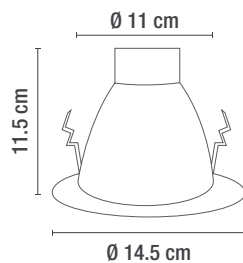

EM2015C-E27/S

CÓDIGO	DESCRIPCIÓN	APLICACIÓN	MATERIA PRIMA	TERMINADO	POTENCIA MÁX. (W)	VOLTAJE (RANGO)	VAC-HZ	CORTE DE EMPOTRAMIENTO	TIPO DE SOCKET	No. DE SOCKETS
EM2015-E27/B	LUMINARIA PARA EMPOTRAR EN TECHO	INTERIOR	ACERO - ALUMINIO	BLANCO SATINADO	60 W	127 V~	50-60 Hz	Ø 11.7 cm	E27	1
EM2015C-E27/S	LUMINARIA PARA EMPOTRAR EN TECHO	INTERIOR	ACERO - CRISTAL	SATINADO BLANCO	60 W	127 V~	50-60 Hz	Ø 11.7 cm	E27	1



H2010/B

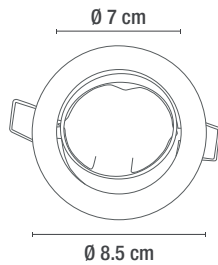

H5010/S

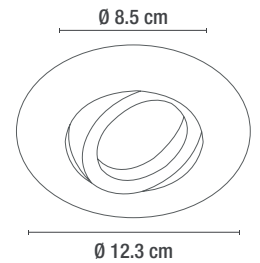

H4010/B

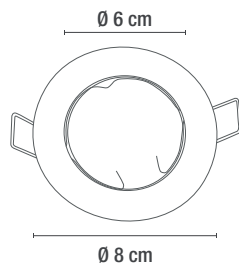

H5001/BL

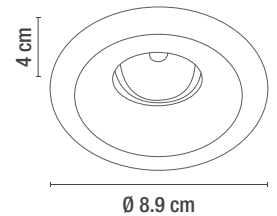

*ESTAS LUMINARIAS NO INCLUYEN LÁMPARAS

CÓDIGO	DESCRIPCIÓN	APLICACIÓN	MATERIA PRIMA	TERMINADO	POTENCIA MÁX. (W)	VOLTAJE (RANGO)	VAC-HZ	CORTE DE EMPOTRAMIENTO	TIPO DE SOCKET	No. DE SOCKETS
H2010/B H2010/S	LUMINARIA DIRIGIBLE PARA EMPOTRAR EN TECHO	INTERIOR	ALUMINIO	BLANCO SATINADO	50 W	127 V~	50-60 Hz	Ø 7 cm	GX5.3	1
H5010/S H5010/B	LUMINARIA DIRIGIBLE PARA EMPOTRAR EN TECHO	INTERIOR	ALUMINIO	SATINADO BLANCO	50 W	127 V~	50-60 Hz	Ø 8,5 cm	GX5.3	1
H4010/B H4010/S	LUMINARIA PARA EMPOTRAR EN TECHO	INTERIOR	ACERO	BLANCO SATINADO	50 W	127 V~	50-60 Hz	Ø 6 cm	GX5.3	1
H5001/BL	LUMINARIA PARA EMPOTRAR EN TECHO	INTERIOR	ALUMINIO	BLANCO	50 W	127 V~	50-60 Hz	Ø 7,7 cm	GU10	1



VINT44-4WE27

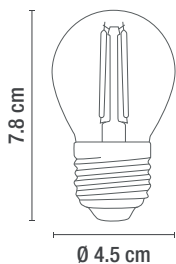

VINT33-4WE27

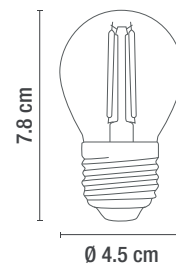

VINT22-4WE27

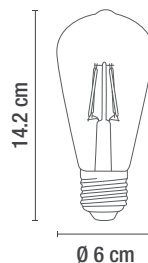

CÓDIGO	DESCRIPCIÓN	APLICACIÓN	MATERIA PRIMA	TERMINADO	POTENCIA MÁX. (W)	VOLTAJE (RANGO)	VAC-HZ	VIDA PROMEDIO (h)	LUMENS	TEMPERATURA	BASE
VINT44-4WE27	LÁMPARA DE TIPO EDISON	INTERIOR	CRISTAL	ÁMBAR	4 W	110-130 V~	50-60 Hz	15,000 h	350 lm	2700 K 2200 K	E27
VINT33-4WE27	LÁMPARA DE TIPO EDISON	INTERIOR	CRISTAL	TRANSPARENTE	4 W	110-130 V~	50-60 Hz	15,000 h	400 lm	2700 K 2200 K	E27
VINT22-4WE27	LÁMPARA DE TIPO EDISON	INTERIOR	CRISTAL	ÁMBAR	4 W	110-130 V~	50-60 Hz	15,000 h	350 lm	2700 K 2200 K	E27



GU10SMD5W/F

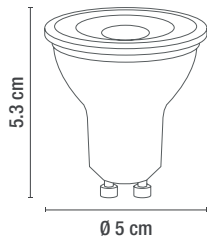

MR16SMD5W/F

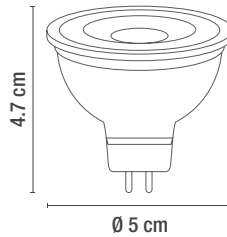

P45SMD4W/C

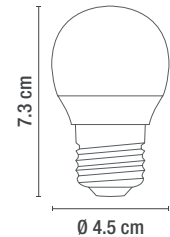

GX538W-E27/C

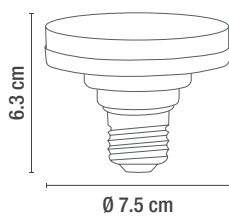

FA199W-E27/C

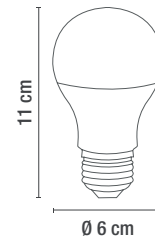

CÓDIGO	DESCRIPCIÓN	APLICACIÓN	MATERIA PRIMA	TERMINADO	POTENCIA MÁX. (W)	VOLTAJE (RANGO)	VAC-HZ	VIDA PROMEDIO (h)	ÁNGULO DE APERTURA	LUMENS	TEMPERATURA	BASE
GU10SMD5W/F GU10SMD5W/C	LÁMPARA DE LED	INTERIOR	ALUMINIO + PLÁSTICO	BLANCO	5 W	110 - 240 V~	50-60 Hz	15,000 h	35°	350 lm	3000 K	GU10
MR16SMD5W/F MR16SMD5W/C	LÁMPARA DE LED	INTERIOR	ALUMINIO + PLÁSTICO	BLANCO	5 W	110 - 240 V~	50-60 Hz	15,000 h	35°	350 lm	6500 K 3000 K	GX5.3
P45SMD4W/C	LÁMPARA DE LED	INTERIOR	ALUMINIO + PLÁSTICO	TRANSPARENTE	4.5W	110 - 240 V~	50-60 Hz	15,000 h	260°	380 lm	3000 K	E27
GX538W-E27/C GX538W-E27/F	LÁMPARA DE LED	INTERIOR	ALUMINIO + PLÁSTICO	BLANCO	8 W	110 - 240 V~	50-60 Hz	15,000 h	120 °	800 lm	3000 K 6500 K	E27
FA199W-E27/C FA199W-E27/F	LÁMPARA DE LED	INTERIOR	ALUMINIO + PLÁSTICO	BLANCO	10 W	110 - 240 V~	50-60 Hz	15,000 h	230°	800 lm	3000 K 6500 K	E27

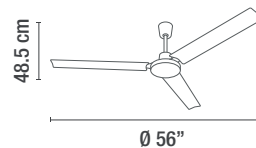

VINDGD

*INCLUYE CONTROL
*NO INCLUYE GANCHO



GAVE

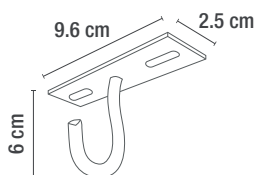

CGDR

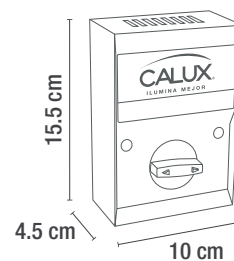

CÓDIGO	DESCRIPCIÓN	APLICACIÓN	MATERIA PRIMA	TERMINADO	POTENCIA MÁX. (W)	VOLTAJE (RANGO)	VAC-HZ
VINDGD	VENTILADOR	INTERIOR	ACERO	BLANCO	60 W	127 V~	50-60 Hz
GAVE	GANCHO PARA VENTILADOR	INTERIOR	ACERO	ACERO TROPICALIZADO	N/A	N/A	N/A
CGDR	CONTROL DE VELOCIDAD DE VENTILADOR	INTERIOR	PLÁSTICO	BLANCO	80 W	127 V~	50-60 Hz





- 98 Cortesía LED
- 107 Arbotantes
- 114 Luminarias de lectura
- 116 Arbotantes Dirigibles LED
- 118 Arbotantes Dirigibles
- 124 Luminarias y barras de baño LED
- 126 Luminarias y barras de baño
- 128 Arbotantes LED
- 146 Arbotantes
- 164 Faroles
- 170 Reflectores LED

Línea de muro

96

Luminarias de Muro

Diseñados para elevar la belleza de tus interiores o para soportar las diferentes condiciones climáticas del exterior, nuestra colección de luminarias de muro permite libertad para crear ambientes jugando con la luz para convertir cualquier estancia en algo único y especial.

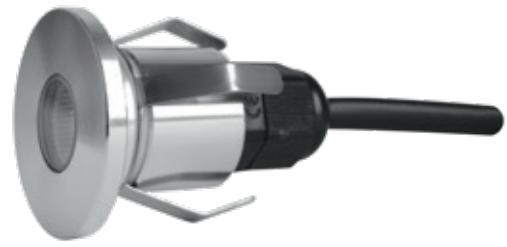

0120-LED

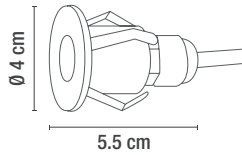

0120-LED

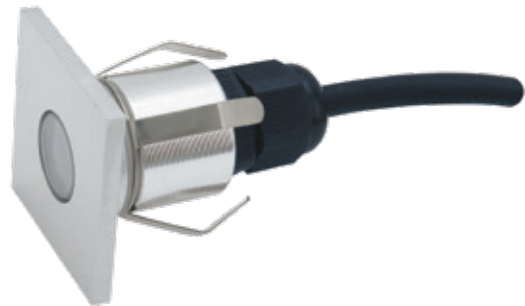

0220-LED

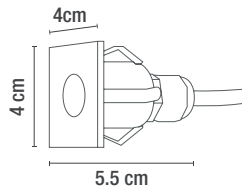

CÓDIGO	DESCRIPCIÓN	APLICACIÓN	MATERIA PRIMA	TERMINADO	POTENCIA MÁX. (W)	VOLTAJE (RANGO)	VAC-Hz	IP	VIDA PROMEDIO (h)	ÁNGULO DE APERTURA	LUMENS (lm)	IRC (CRI)	TEMPERATURA (K)	CORTE DE EMPOTRAMIENTO
0120-LED	LUMINARIA LED PARA EMPOTRAR EN MURO	EXTERIOR	ALUMINIO / CRISTAL	ALUMINIO	1W	100-240 V~	50-60 Hz	65	30000 h	20°	72 lm	80	3 000 K	Ø 2.5 cm
0220-LED	LUMINARIA LED PARA EMPOTRAR EN MURO	EXTERIOR	ALUMINIO / CRISTAL	ALUMINIO	1W	100-240 V~	50-60 Hz	65	30000 h	20°	72 lm	80	3 000 K	Ø 2.5 cm



3520-LED

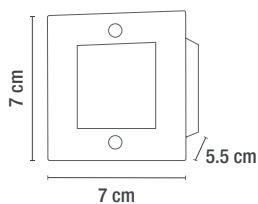

3620-LED

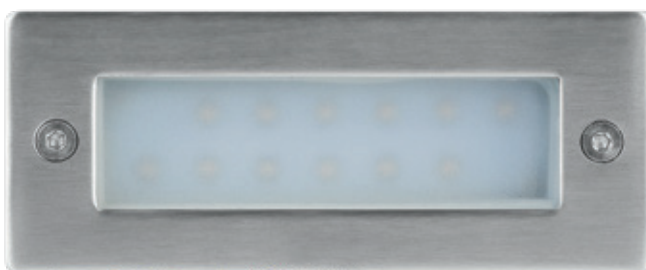
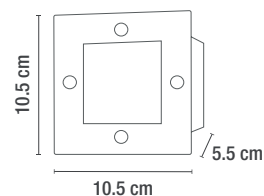

3720-LED

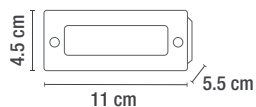

CÓDIGO	DESCRIPCIÓN	APLICACIÓN	MATERIA PRIMA	TERMINADO	POTENCIA MÁX. (W)	VOLTAJE (RANGO)	VAC-Hz	IP	VIDA PROMEDIO (h)	ÁNGULO DE APERTURA	LUMENS (lm)	IRC (CRI)	TEMPERATURA (K)	CORTE DE EMPOTRAMIENTO
3520-LED	LUMINARIA LED PARA EMPOTRAR EN MURO	EXTERIOR	ACERO INOX / CRISTAL	ACERO INOXIDABLE	0.9 W	100-130 V~	50-60 Hz	65	30000 h	100°-110°	47 lm	80	3 000 K	Ø 6.5 x 6.4 cm
3620-LED	LUMINARIA LED PARA EMPOTRAR EN MURO	EXTERIOR	ACERO INOX / CRISTAL	ACERO INOXIDABLE	1.6 W	100-130 V~	50-60 Hz	65	30000 h	100°-110°	70 lm	80	3 000 K	Ø 9.5 x 9.5 cm
3720-LED	LUMINARIA LED PARA EMPOTRAR EN MURO	EXTERIOR	ACERO INOX / CRISTAL	ACERO INOXIDABLE	1.2 W	100-130 V~	50-60 Hz	65	30000 h	100°-110°	52 lm	80	3 000 K	Ø 10.4 x 5.5 cm



3320-LED

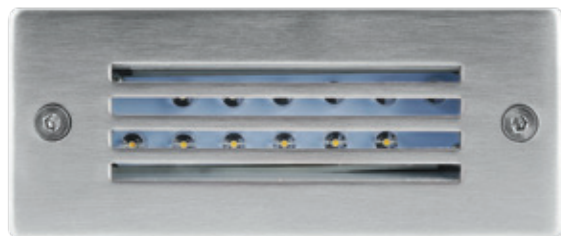

3320-LED

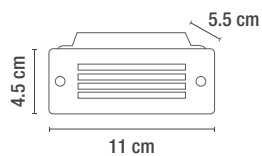

3420-LED

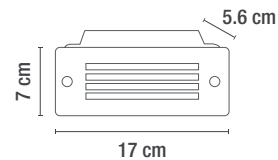

CÓDIGO	DESCRIPCIÓN	APLICACIÓN	MATERIA PRIMA	TERMINADO	POTENCIA MÁX. (W)	VOLTAJE (RANGO)	VAC-Hz	IP	VIDA PROMEDIO (h)	ÁNGULO DE APERTURA	LUMENS (lm)	IRC (CRI)	TEMPERATURA (K)	CORTE DE EMPOTRAMIENTO
3320-LED	LUMINARIA LED PARA EMPOTRAR EN MURO	EXTERIOR	ACERO INOX / CRISTAL	ACERO INOXIDABLE	1.2 W	100-130 V~	50-60 Hz	65	30000 h	100°-110°	52 lm	80	3 000 K	Ø 10.4 x 4 cm
3420-LED	LUMINARIA LED PARA EMPOTRAR EN MURO	EXTERIOR	ACERO INOX / CRISTAL	ACERO INOXIDABLE	1.6 W	100-130 V~	50-60 Hz	65	30000 h	100°-110°	70 lm	80	3 000 K	Ø 15.8 x 5.4 cm



9220-LED

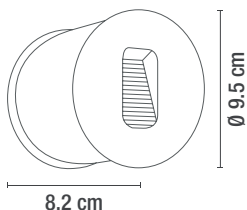

9221-LED

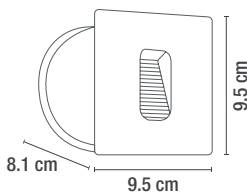

9221-LED



CÓDIGO	DESCRIPCIÓN	APLICACIÓN	MATERIA PRIMA	TERMINADO	POTENCIA MÁX. (W)	VOLTAJE (RANGO)	VAC-Hz	IP	VIDA PROMEDIO (h)	ÁNGULO DE APERTURA	LUMENS (lm)	IRC (CRI)	TEMPERATURA (K)	CORTE DE EMPOTRAMIENTO
9220-LED	LUMINARIA LED PARA EMPOTRAR EN MURO	EXTERIOR	ACERO INOX	ACERO INOXIDABLE	3 W	100-240 V~	50-60 Hz	65	30000 h	62°	54 lm	80	3 000 K	Ø 9.1 cm
9221-LED	LUMINARIA LED PARA EMPOTRAR EN MURO	EXTERIOR	ACERO INOX	ACERO INOXIDABLE	3 W	100-240 V~	50-60 Hz	65	30000 h	62°	54 lm	80	3 000 K	Ø 9.1 cm

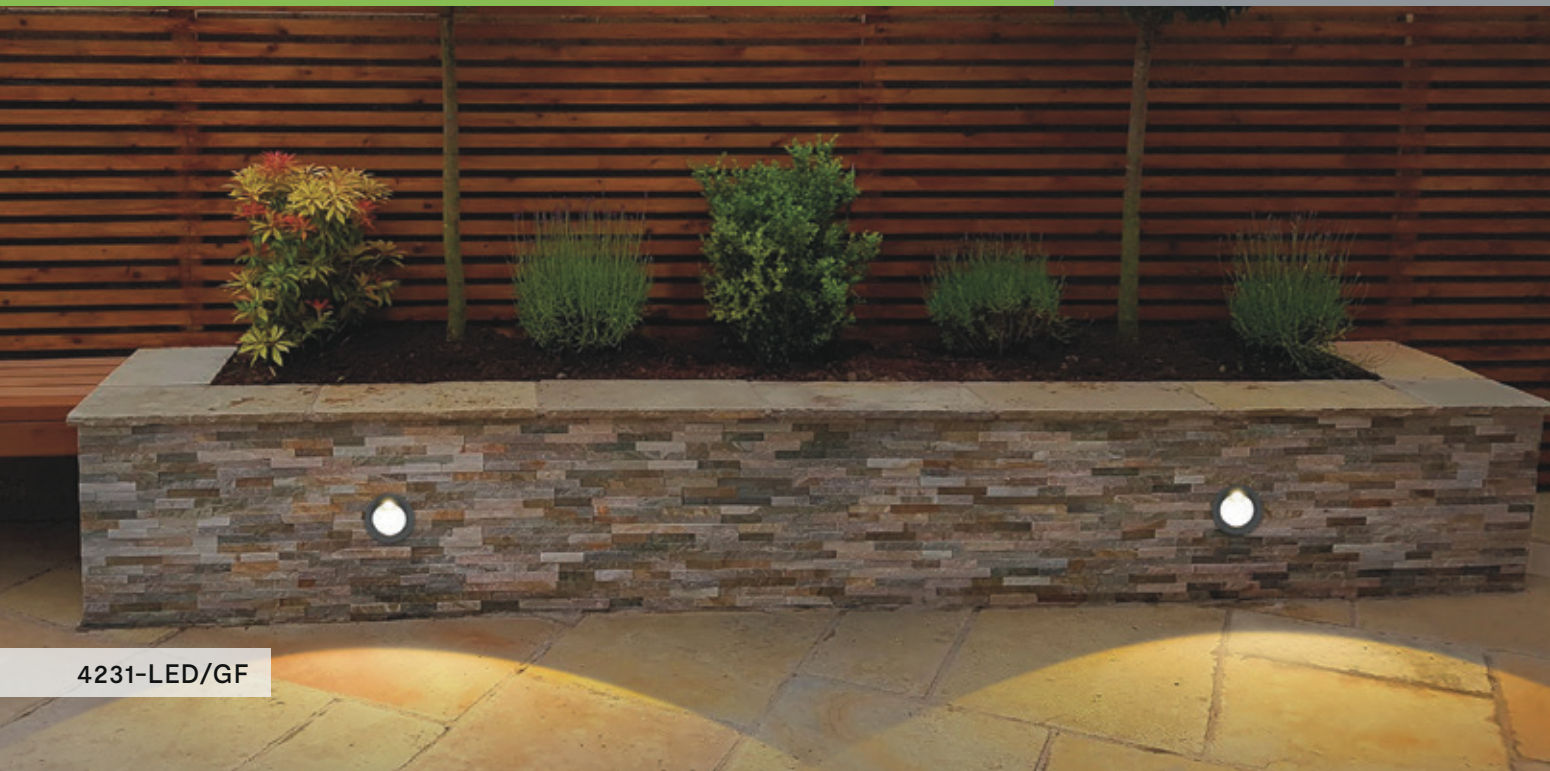

4231-LED/GF



4231-LED/GF

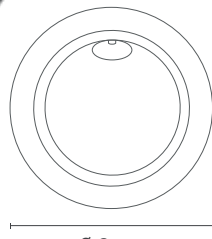

Ø 8 cm



4232-LED/GF

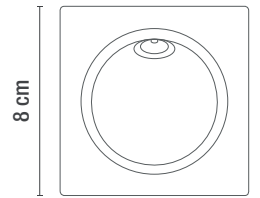

8 cm

8 cm



CÓDIGO	DESCRIPCIÓN	APLICACIÓN	MATERIA PRIMA	TERMINADO	POTENCIA MÁX. (W)	VOLTAJE (RANGO)	VAC-Hz	IP	VIDA PROMEDIO (h)	ÁNGULO DE APERTURA	LUMENS (lm)	IRC (CRI)	TEMPERATURA (K)	CORTE DE EMPOTRAMIENTO
4231-LED/GF	LUMINARIA LED PARA EMPOTRAR EN MURO	EXTERIOR	ALUMINIO	GRAFITO	3 W	100-240 V~	50-60 Hz	54	25000 h	73°	90 lm	80	3 000 K	Ø 7.35 x 7.35 cm
4232-LED/GF	LUMINARIA LED PARA EMPOTRAR EN MURO	EXTERIOR	ALUMINIO	GRAFITO	3 W	100-240 V~	50-60 Hz	54	25000 h	50°	100 lm	80	3 000 K	Ø 7.35 x 7.35 cm



4720-LED

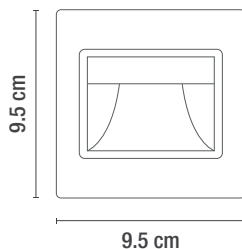

4720-LED/BL

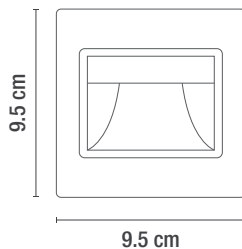

4720-LED



CÓDIGO	DESCRIPCIÓN	APLICACIÓN	MATERIA PRIMA	TERMINADO	POTENCIA MÁX. (W)	VOLTAJE (RANGO)	VAC-Hz	IP	VIDA PROMEDIO (h)	ÁNGULO DE APERTURA	LUMENS (lm)	IRC (CRI)	TEMPERATURA (K)	CORTE DE EMPOTRAMIENTO
4720-LED 4720-LED/BL	LUMINARIA LED PARA EMPOTRAR EN MURO	INTERIOR	PLÁSTICO ABS / PLÁSTICO	GRIS BLANCO	1.2 W	100-240 V~	50-60 Hz	23	30000 h	120°	40 lm	80	3 000 K	Ø 8 x 8 cm



8920-LED/GR

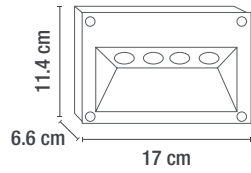

9020-LED

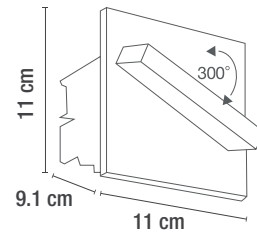

CÓDIGO	DESCRIPCIÓN	APLICACIÓN	MATERIA PRIMA	TERMINADO	POTENCIA MÁX. (W)	VOLTAJE (RANGO)	VAC-Hz	IP	VIDA PROMEDIO (h)	ÁNGULO DE APERTURA	LUMENS (lm)	IRC (CRI)	TEMPERATURA (K)	CORTE DE EMPOTRAMIENTO
8920-LED/GR	LUMINARIA LED PARA EMPOTRAR EN MURO	EXTERIOR	ALUMINIO	GRIS	4 W	100-240 V~	50-60 Hz	65	30000 h	31°	327 lm	80	3 000 K	Ø 16.4 x 10.7 cm
9020-LED	LUMINARIA LED PARA EMPOTRAR EN MURO	EXTERIOR	ALUMINIO	GRIS	3 W	100-240 V~	50-60 Hz	65	30000 h	88°	58 lm	80	3 000 K	Ø 9.7 x 6 cm



4020-LED/G

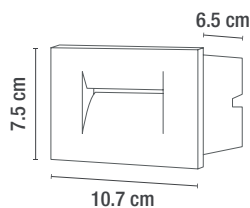

4020-LED/B

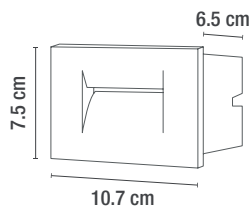

4020-LED/G



CÓDIGO	DESCRIPCIÓN	APLICACIÓN	MATERIA PRIMA	TERMINADO	POTENCIA MÁX. (W)	VOLTAJE (RANGO)	VAC-Hz	IP	VIDA PROMEDIO (h)	ÁNGULO DE APERTURA	LUMENS (lm)	IRC (CRI)	TEMPERATURA (K)	CORTE DE EMPOTRAMIENTO
4020-LED/G 4020-LED/B	LUMINARIA LED PARA EMPOTRAR EN MURO	EXTERIOR	ALUMINIO / CRISTAL	GRIS BLANCO	3.6 W	100-240 V~	50-60 Hz	65	30000 h	33°	70 lm	80	3 000 K	Ø 9.6 x 6 cm

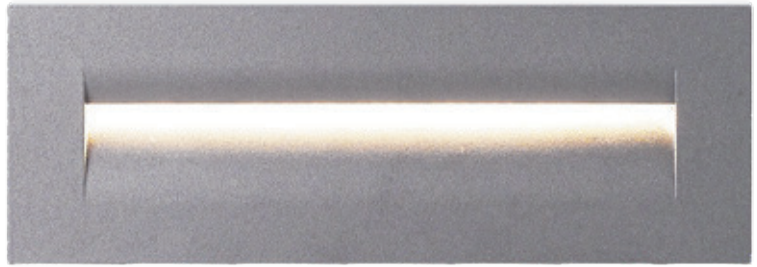

1712-LED/GR

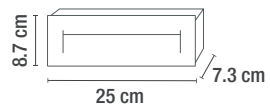

2220-LED

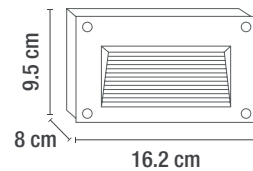

1712-LED/



CÓDIGO	DESCRIPCIÓN	APLICACIÓN	MATERIA PRIMA	TERMINADO	POTENCIA MÁX. (W)	VOLTAJE (RANGO)	VAC-Hz	IP	VIDA PROMEDIO (h)	ÁNGULO DE APERTURA	LUMENS (lm)	IRC (CRI)	TEMPERATURA (K)	CORTE DE EMPOTRAMIENTO
1712-LED/GR	LUMINARIA LED PARA EMPOTRAR EN MURO	EXTERIOR	ALUMINIO	GRIS	8.5 W	100-240 V~	50-60 Hz	65	30000 h	42°	600 lm	80	3 000 K	Ø 7.3 x 23.8 cm
2220-LED	LUMINARIA LED PARA EMPOTRAR EN MURO	EXTERIOR	ALUMINIO	GRIS	1.2 W	100-240 V~	50-60 Hz	54	30000 h	100°	40 lm	80	3 000 K	Ø 15.8 x 9.7 cm

PRODUCTO NUEVO



MU0319/OR

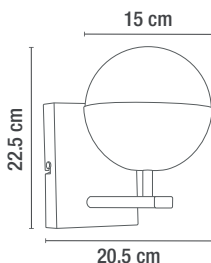

PRODUCTO NUEVO



Hecho en México

AFG06/OX

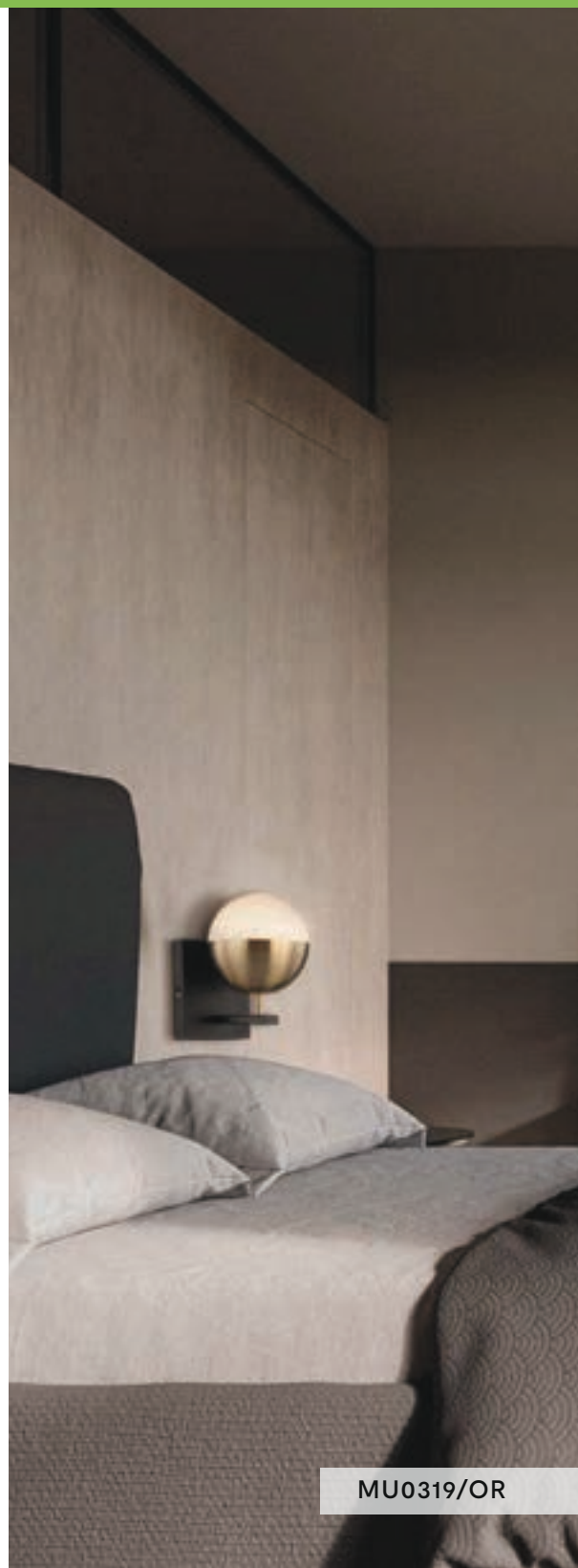
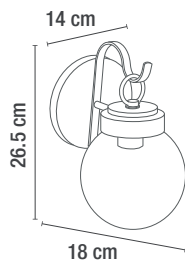

MU0319/OR

CÓDIGO	DESCRIPCIÓN	APLICACIÓN	MATERIA PRIMA	TERMINADO	POTENCIA MÁX. (W)	VOLTAJE (RANGO)	VAC-Hz	IP	TIPO DE SOCKET	No. DE SOCKET
MU0319/OR	LUMINARIA DE SOBREPONER PARA MURO	INTERIOR	ACERO / CRISTAL	BRONCE	40 W	125 V~	50-60 Hz	20	E27	1
AFG06/OX	LUMINARIA DE SOBREPONER PARA MURO	EXTERIOR	ACERO FORJADO / CRISTAL	ÓXIDO	60 W	127 V~	50-60 Hz	54	E27	1

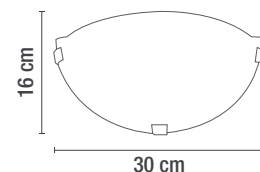

AJB11-12



A2028-1/S

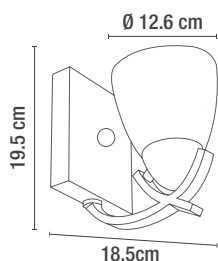

96291

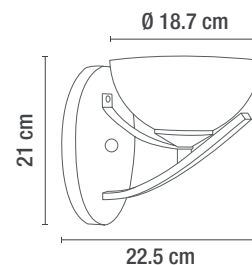

CÓDIGO	DESCRIPCIÓN	APLICACIÓN	MATERIA PRIMA	TERMINADO	POTENCIA MÁX. (W)	VOLTAJE (RANGO)	VAC-Hz	IP	TIPO DE SOCKET	No. DE SOCKET
AJB11-12	LUMINARIA DE SOBREPONER PARA MURO	INTERIOR	ACERO / CRISTAL	ÁCIDO	60 W	127 V~	50-60 Hz	20	E27	1
A2028-1/S	LUMINARIA DE SOBREPONER PARA MURO	INTERIOR	ACERO / CRISTAL	SATINADO	60 W	127 V~	50-60 Hz	20	E27	1
96291	LUMINARIA DE SOBREPONER PARA MURO	INTERIOR	ACERO / CRISTAL	SATINADO	60 W	127 V~	50-60 Hz	20	E27	1



AS1L/S

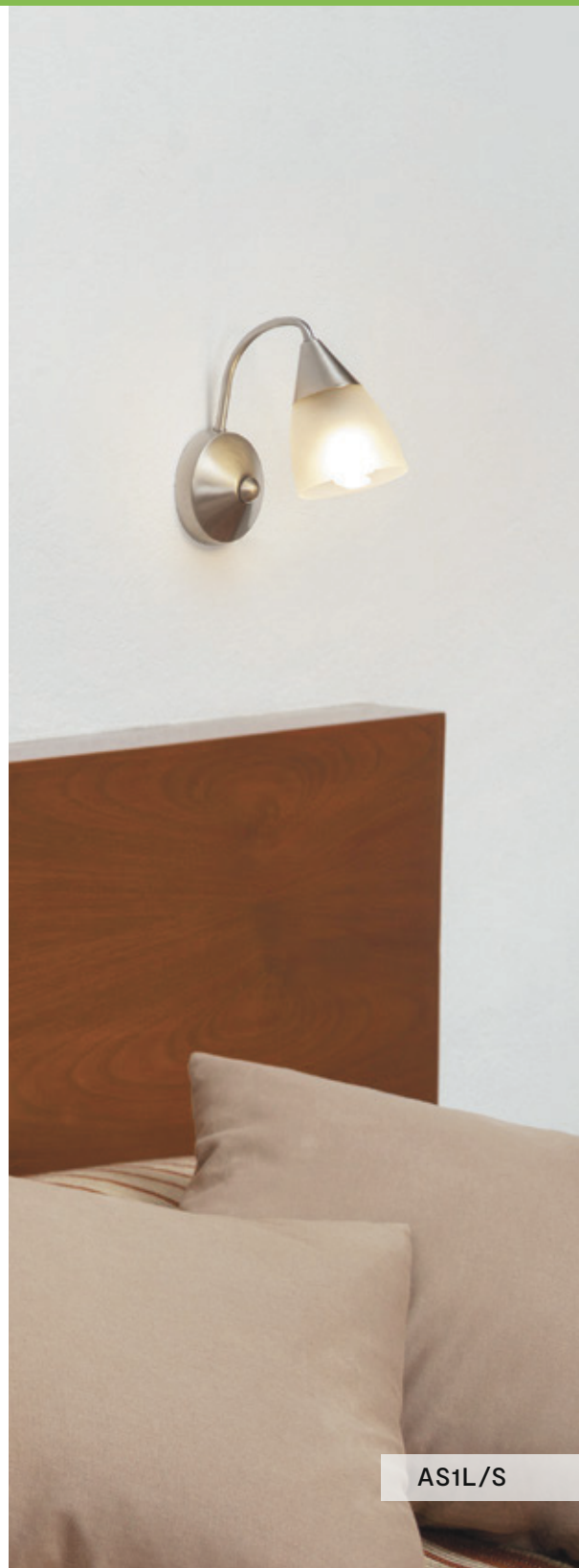
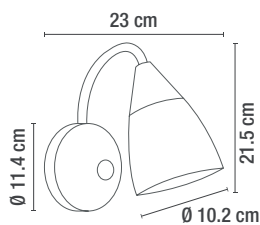

AS1L/S



AS1L/CH

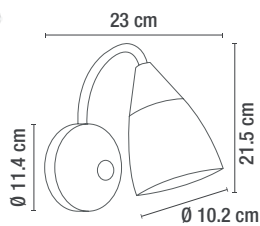

CÓDIGO	DESCRIPCIÓN	APLICACIÓN	MATERIA PRIMA	TERMINADO	POTENCIA MÁX. (W)	VOLTAJE (RANGO)	VAC-Hz	IP	TIPO DE SOCKET	No. DE SOCKET
AS1L/S	LUMINARIA DE SOBREPONER PARA MURO	INTERIOR	ACERO / CRISTAL ACÍDO	SATINADO	60 W	127 V~	50-60 Hz	20	E27	1
AS1L/CH	LUMINARIA DE SOBREPONER PARA MURO	INTERIOR	ACERO / CRISTAL ACÍDO	CHOCOLATE	60 W	127 V~	50-60 Hz	20	E27	1

Hecho en México



AFK1L/O

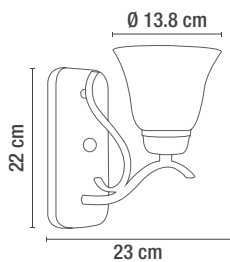

A2028-1/CO

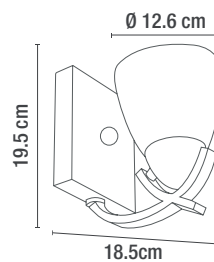

CÓDIGO	DESCRIPCIÓN	APLICACIÓN	MATERIA PRIMA	TERMINADO	POTENCIA MÁX. (W)	VOLTAJE (RANGO)	VAC-Hz	IP	TIPO DE SOCKET	No. DE SOCKET
AFK1L/O	LUMINARIA DE SOBREPONER PARA MURO	INTERIOR	ACERO / CRISTAL	ÓXIDO	60 W	127 V~	50-60 Hz	20	E27	1
A2028-1/CO	LUMINARIA DE SOBREPONER PARA MURO	INTERIOR	ACERO / CRISTAL	CAFÉ OBSCURO	60 W	127 V~	50-60 Hz	20	E27	1

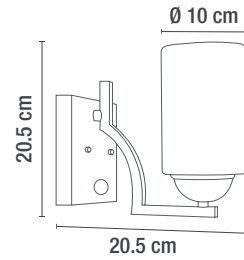

94991/ONIX/O

*EL TONO DE PIEDRA DE ESTE PRODUCTO PUEDE VARIAR AL SER UN PRODUCTO NATURAL

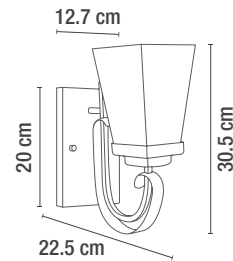

A1081-1



CÓDIGO	DESCRIPCIÓN	APLICACIÓN	MATERIA PRIMA	TERMINADO	POTENCIA MÁX. (W)	VOLTAJE (RANGO)	VAC-Hz	IP	TIPO DE SOCKET	No. DE SOCKET
94991/ONIX/O	LUMINARIA DE SOBREPONER PARA MURO	INTERIOR	ACERO / ONIX NATURAL	ÓXIDO	60 W	127 V~	50-60 Hz	20	E27	1
A1081-1	LUMINARIA DE SOBREPONER PARA MURO	INTERIOR	ACERO / CRISTAL	VERDE ANTIGUO	60 W	127 V~	50-60 Hz	20	E27	1



Hecho en México

OXC200/P

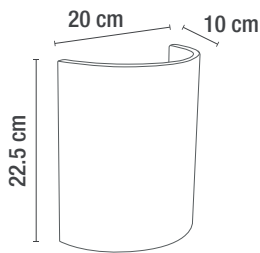

Hecho en México

OXC200PQ/B

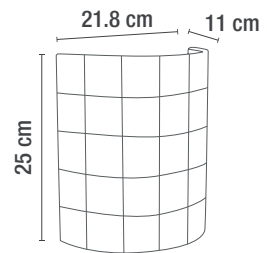

Hecho en México

OXC200PQ/P

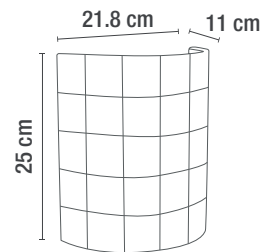

*EL TONO DE PIEDRA DE ESTE PRODUCTO PUEDE VARIAR AL SER UN PRODUCTO NATURAL

CÓDIGO	DESCRIPCIÓN	APLICACIÓN	MATERIA PRIMA	TERMINADO	POTENCIA MÁX. (W)	VOLTAJE (RANGO)	VAC-Hz	IP	TIPO DE SOCKET	No. DE SOCKET
OXC200/P	LUMINARIA DE SOBREPONER PARA MURO	INTERIOR	ONIX NATURAL	PIÑA	60 W	127 V~	50-60 Hz	20	E27	1
OXC200PQ/B	LUMINARIA DE SOBREPONER PARA MURO	INTERIOR	ONIX NATURAL	BLANCO	60 W	127 V~	50-60 Hz	20	E27	1
OXC200PQ/P	LUMINARIA DE SOBREPONER PARA MURO	INTERIOR	ONIX NATURAL	PIÑA	60 W	127 V~	50-60 Hz	20	E27	1

Hecho en México

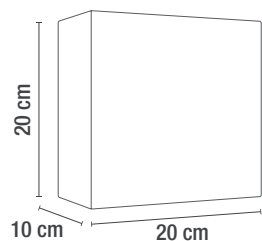

OXG212/P

Hecho en México

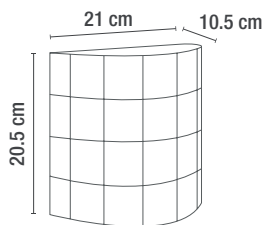

OXC120PQ/P



*EL TONO DE PIEDRA DE ESTE PRODUCTO PUEDE VARIAR AL SER UN PRODUCTO NATURAL



OXC120PQ/P

CÓDIGO	DESCRIPCIÓN	APLICACIÓN	MATERIA PRIMA	TERMINADO	POTENCIA MÁX. (W)	VOLTAJE (RANGO)	VAC-Hz	IP	TIPO DE SOCKET	No. DE SOCKET
OXG212/P	LUMINARIA DE SOBREPONER PARA MURO	INTERIOR	ONIX NATURAL	PIÑA	60 W	127 V~	50-60 Hz	20	E27	1
OXC120PQ/P	LUMINARIA DE SOBREPONER PARA MURO	INTERIOR	ONIX NATURAL	PIÑA	60 W	127 V~	50-60 Hz	20	E27	1



F1090/CR



F1090/CR

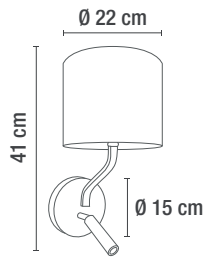

F1091/CR

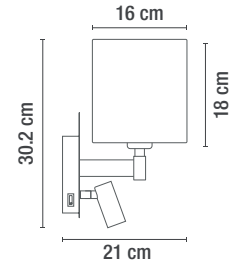

F1092/CR

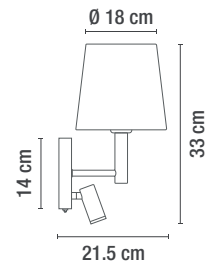

CÓDIGO	DESCRIPCIÓN	APLICACIÓN	MATERIA PRIMA	TERMINADO	POTENCIA MÁX. (W)	VOLTAJE (RANGO)	VAC-Hz	IP	TIPO DE SOCKET	No. DE SOCKET
F1090/CR	LUMINARIA DE SOBREPONER EN MURO CON LUZ LED DIRIGIBLE	INTERIOR	ACERO / TELA	CROMO	40 W	100-240 V~	50-60 Hz	20	E27 - LED	1
F1091/CR	LUMINARIA DE SOBREPONER EN MURO CON LUZ LED DIRIGIBLE	INTERIOR	ACERO / TELA	CROMO	40 W	127 V~	50-60 Hz	20	E27 - LED	1
F1092/CR	LUMINARIA DE SOBREPONER EN MURO CON LUZ LED DIRIGIBLE	INTERIOR	ACERO / TELA	CROMO	40 W	127 V~	50-60 Hz	20	E27 - LED	1



F2130-3W



F2130-3W

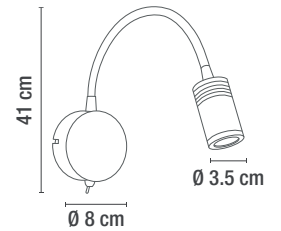

F1095-LED/SA

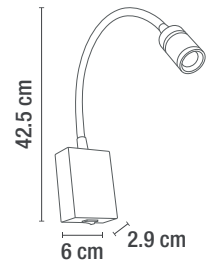

CÓDIGO	DESCRIPCIÓN	APLICACIÓN	MATERIA PRIMA	TERMINADO	POTENCIA MÁX. (W)	VOLTAJE (RANGO)	VAC-Hz	IP	VIDA PROMEDIO (h)	ÁNGULO DE APERTURA	LUMENS (lm)	IRC (CRI)	TEMPERATURA (K)
F2130-3W	LUMINARIA DIRIGIBLE DE SOBREPONER EN MURO	INTERIOR	ACERO	SATINADO	3 W	127 V~	50-60 Hz	20	25000 h	30°	250 lm	80	3 000 K
F1095-LED/SA	LUMINARIA DIRIGIBLE DE SOBREPONER EN MURO	INTERIOR	ACERO	SATINADO	3 W	100-240 V~	50-60 Hz	20	20000 h	45°	171 lm	80	3 000 K



F1093-LED/CR

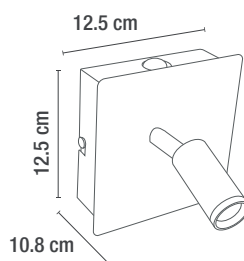

CL-1203-3-LED/CR

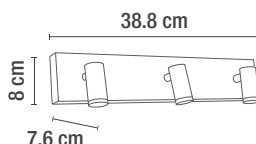

CÓDIGO	DESCRIPCIÓN	APLICACIÓN	MATERIA PRIMA	TERMINADO	POTENCIA MÁX. (W)	VOLTAJE (RANGO)	VAC-Hz	IP	VIDA PROMEDIO (h)	ÁNGULO DE APERTURA	LUMENS (lm)	IRC (CRI)	TEMPERATURA (K)
F1093-LED/CR	LUMINARIA DIRIGIBLE DE SOBREPONER EN MURO	INTERIOR	ALUMINIO / ACERO	CROMO	6 W	100-240 V~	50-60 Hz	20	20000 h	60° - 45°	319 lm	80	3 000 K
CL-1203-3-LED/CR	LUMINARIA DIRIGIBLE DE SOBREPONER EN MURO	INTERIOR	ALUMINIO / ACERO	CROMO	15 W	100-240 V~	50-60 Hz	44	20000 h	45°	1600 lm	80	3 000 K



4500-1-GU10/SA

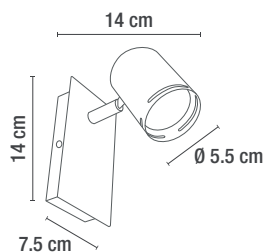

4500-3-GU10/SA

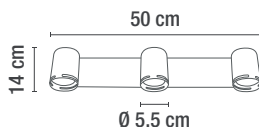

*ESTAS LUMINARIAS NO INCLUYEN LÁMPARA

CÓDIGO	DESCRIPCIÓN	APLICACIÓN	MATERIA PRIMA	TERMINADO	POTENCIA MÁX. (W)	VOLTAJE (RANGO)	VAC-Hz	IP	TIPO DE SOCKET	No. DE SOCKET
4500-1-GU10/SA	LUMINARIA DIRIGIBLE DE SOBREPONER EN MURO Y TECHO	INTERIOR	ACERO	SATINADO	35 W	127 V~	50-60 Hz	20	GU10	1
4500-3-GU10/SA	LUMINARIA DIRIGIBLE DE SOBREPONER EN MURO Y TECHO	INTERIOR	ACERO	SATINADO	105 W	127 V~	50-60 Hz	20	GU10	3



HS-6020-1/NE

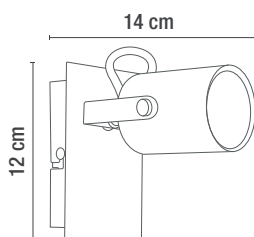

HS-6021-2/NE

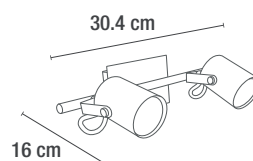

HS-6022-3/NE

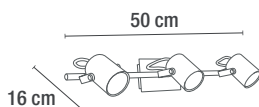

*ESTAS LUMINARIAS NO INCLUYEN LÁMPARA

CÓDIGO	DESCRIPCIÓN	APLICACIÓN	MATERIA PRIMA	TERMINADO	POTENCIA MÁX. (W)	VOLTAJE (RANGO)	VAC-Hz	IP	TIPO DE SOCKET	No. DE SOCKET
HS-6020-1/NE	LUMINARIA DIRIGIBLE DE SOBREPONER EN MURO Y TECHO	INTERIOR	ACERO	MADERA/NEGRO	35 W	127 V~	50-60 Hz	20	GU10	1
HS-6021-2/NE	LUMINARIA DIRIGIBLE DE SOBREPONER EN MURO Y TECHO	INTERIOR	ACERO	MADERA/NEGRO	70 W	127 V~	50-60 Hz	20	GU10	2
HS-6022-3/NE	LUMINARIA DIRIGIBLE DE SOBREPONER EN MURO Y TECHO	INTERIOR	ACERO	MADERA/NEGRO	105 W	127 V~	50-60 Hz	20	GU10	3



HS-5015-1/NE



HS-5015-1/NE

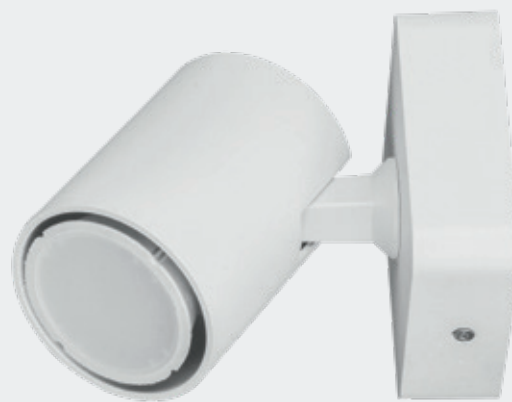
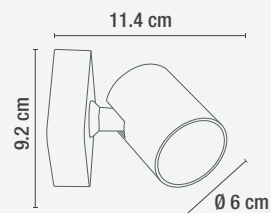

HS-5015-1/BL

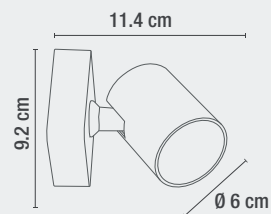

*ESTAS LUMINARIAS NO INCLUYEN LÁMPARA

CÓDIGO	DESCRIPCIÓN	APLICACIÓN	MATERIA PRIMA	TERMINADO	POTENCIA MÁX. (W)	VOLTAJE (RANGO)	VAC-Hz	IP	TIPO DE SOCKET	No. DE SOCKET
HS-5015-1/NE HS-5015-1/BL	LUMINARIA DIRIGIBLE DE SOBREPONER EN MURO Y TECHO	INTERIOR	ALUMINIO	NEGRO BLANCO	50 W	100-240 V~	50-60 Hz	20	GU10	1



HS-5015-2/BL

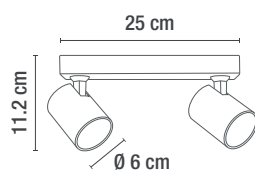

HS-5015-3/BL

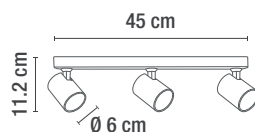

*ESTAS LUMINARIAS NO INCLUYEN LÁMPARA

CÓDIGO	DESCRIPCIÓN	APLICACIÓN	MATERIA PRIMA	TERMINADO	POTENCIA MÁX. (W)	VOLTAJE (RANGO)	VAC-Hz	IP	TIPO DE SOCKET	No. DE SOCKET
HS-5015-2/BL HS-5015-2/NE	LUMINARIA DIRIGIBLE DE SOBREPONER EN MURO Y TECHO	INTERIOR	ALUMINIO / ALUMINIO	BLANCO NEGRO	100 W	100-240 V~	50-60 Hz	20	GU10	1
HS-5015-3/BL HS-5015-3/NE	LUMINARIA DIRIGIBLE DE SOBREPONER EN MURO Y TECHO	INTERIOR	ALUMINIO / ALUMINIO	BLANCO NEGRO	150 W	100-240 V~	50-60 Hz	20	GU10	1



HS-7040-1/NE

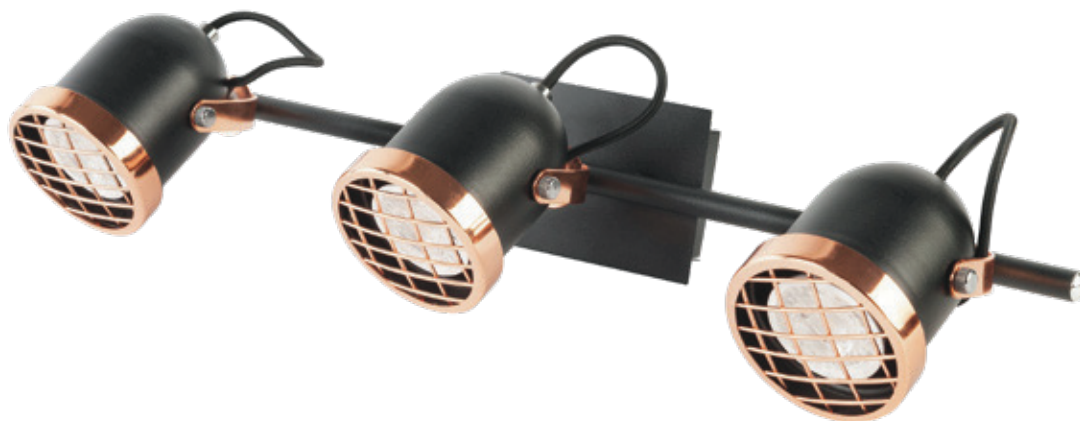
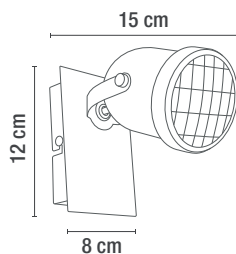

HS-8020-3/NE

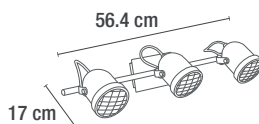

*ESTAS LUMINARIAS NO INCLUYEN LÁMPARA

CÓDIGO	DESCRIPCIÓN	APLICACIÓN	MATERIA PRIMA	TERMINADO	POTENCIA MÁX. (W)	VOLTAJE (RANGO)	VAC-Hz	IP	TIPO DE SOCKET	No. DE SOCKET
HS-7040-1/NE	LUMINARIA DIRIGIBLE DE SOBREPONER EN MURO Y TECHO	INTERIOR	ACERO	NEGRO/COBRE	35 W	127 V~	50-60 Hz	20	GU10	1
HS-8020-3/NE	LUMINARIA DIRIGIBLE DE SOBREPONER EN MURO Y TECHO	INTERIOR	ACERO	NEGRO/COBRE	105 W	127 V~	50-60 Hz	20	GU10	3



HS-5016-1

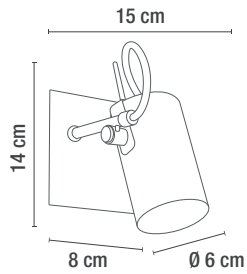

HS-5017-2

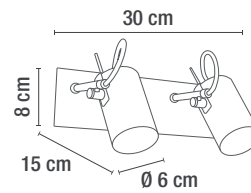

HS-5018-3

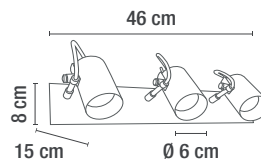

*ESTAS LUMINARIAS NO INCLUYEN LÁMPARA

CÓDIGO	DESCRIPCIÓN	APLICACIÓN	MATERIA PRIMA	TERMINADO	POTENCIA MÁX. (W)	VOLTAJE (RANGO)	VAC-Hz	IP	TIPO DE SOCKET	No. DE SOCKET
HS-5016-1	LUMINARIA DIRIGIBLE DE SOBREPONER EN MURO	INTERIOR	ACERO / CRISTAL	CROMO	50 W	127 V~	50-60 Hz	20	GU10	1
HS-5017-2	LUMINARIA DIRIGIBLE DE SOBREPONER EN MURO	INTERIOR	ACERO / CRISTAL	CROMO	100 W	127 V~	50-60 Hz	20	GU10	2
HS-5018-3	LUMINARIA DIRIGIBLE DE SOBREPONER EN MURO	INTERIOR	ACERO / CRISTAL	CROMO	150 W	127 V~	50-60 Hz	20	GU10	3



CL-1100-1-LED/SA



CL-1100-1-LED/SA

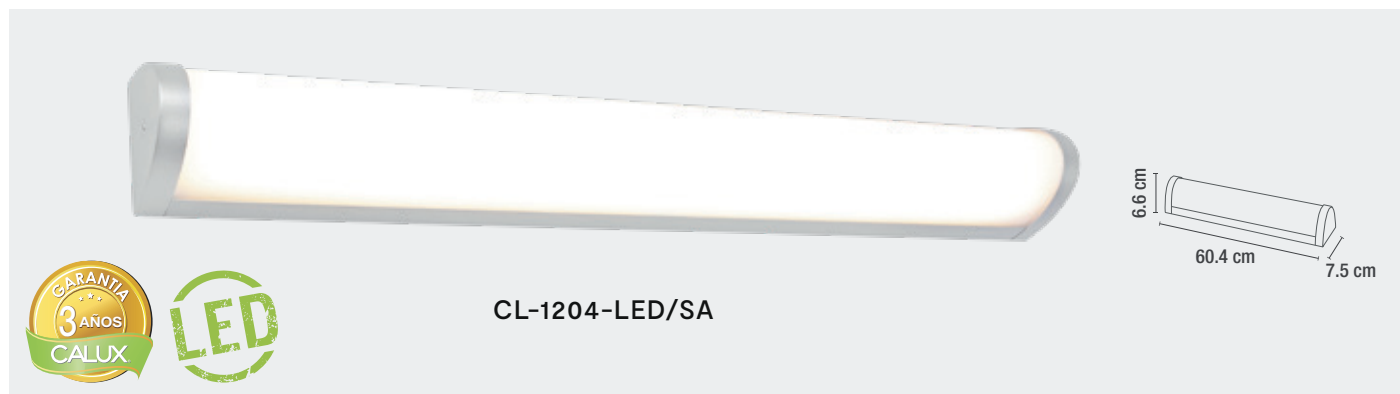
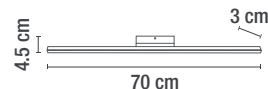

CL-1204-LED/SA

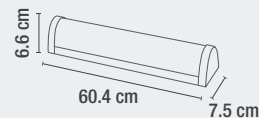

CÓDIGO	DESCRIPCIÓN	APLICACIÓN	MATERIA PRIMA	TERMINADO	POTENCIA MÁX. (W)	VOLTAJE (RANGO)	VAC-Hz	IP	VIDA PROMEDIO (h)	ÁNGULO DE APERTURA	LUMENS (lm)	IRC (CRI)	TEMPERATURA (K)
CL-1100-1-LED/SA	LUMINARIA LED DE SOBREPONER EN MURO	INTERIOR	ACERO / ACRÍLICO	NIQUEL SATINADO	9 W	127 V~	50-60 Hz	20	30000 h	95°	600 lm	N/A	3 000 K
CL-1204-LED/SA	LUMINARIA LED DE SOBREPONER EN MURO	INTERIOR	ALUMINIO / POLICARBONATO	SATÍN	16 W	110 - 127 V~	50-60 Hz	44	20000 h	165°	1200 lm	80	3 000 K



CL-1200-1-LED/CR

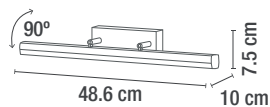

CL-1200-1-LED/NE

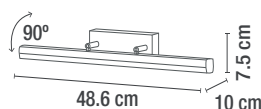

CL-1202-2-LED/CR

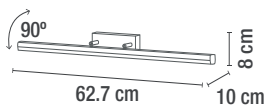

CÓDIGO	DESCRIPCIÓN	APLICACIÓN	MATERIA PRIMA	TERMINADO	POTENCIA MÁX. (W)	VOLTAJE (RANGO)	VAC-Hz	IP	VIDA PROMEDIO (h)	ÁNGULO DE APERTURA	LUMENS (lm)	IRC (CRI)	TEMPERATURA (K)
CL-1200-1-LED/CR	LUMINARIA LED DE SOBREPONER EN MURO	INTERIOR	ALUMINIO / POLICARBONATO	CROMO NEGRO	12 W	100-240 V~	50-60 Hz	44	20000 h	110°	1060 lm	80	3 000 K
CL-1202-2-LED/CR	LUMINARIA LED DE SOBREPONER EN MURO	INTERIOR	ALUMINIO / POLICARBONATO	CROMO	18 W	100-240 V~	50-60 Hz	44	20000 h	110°	1600 lm	80	3 000 K



3112

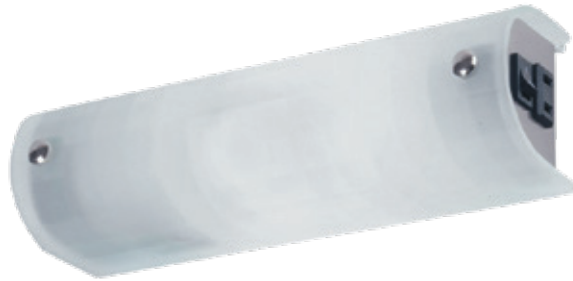
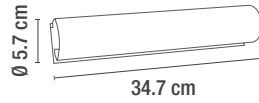

4100

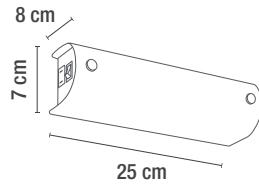

4101

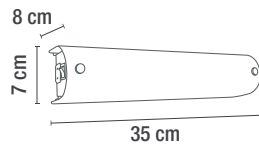

CÓDIGO	DESCRIPCIÓN	APLICACIÓN	MATERIA PRIMA	TERMINADO	POTENCIA MÁX. (W)	VOLTAJE (RANGO)	VAC-Hz	IP	TIPO DE SOCKET	No. DE SOCKET
3112	LUMINARIA DE SOBREPONER PARA MURO	INTERIOR	CRISTAL / CRISTAL	CRISTAL DECORADO	120 W	127 V~	50-60 Hz	23	E27	2
4100	LUMINARIA DE SOBREPONER PARA MURO	INTERIOR	ACERO / CRISTAL	CRISTAL FROST	60 W	127 V~	50-60 Hz	23	E27	1
4101	LUMINARIA DE SOBREPONER PARA MURO	INTERIOR	ACERO / CRISTAL	CRISTAL FROST	120 W	127 V~	50-60 Hz	23	E27	2



V22154W/25

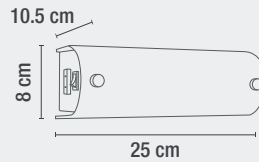

V22154W/35

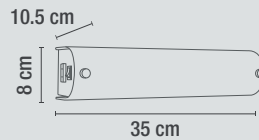

CÓDIGO	DESCRIPCIÓN	APLICACIÓN	MATERIA PRIMA	TERMINADO	POTENCIA MÁX. (W)	VOLTAJE (RANGO)	VAC-Hz	IP	TIPO DE SOCKET	No. DE SOCKET
V22154W/25	LUMINARIA DE SOBREPONER PARA MURO	INTERIOR	ACERO / CRISTAL	CRISTAL FROST	9 W	100-240 V~	50-60 Hz	23	E27	1
V22154W/35	LUMINARIA DE SOBREPONER PARA MURO	INTERIOR	ACERO / CRISTAL	CRISTAL FROST	18 W	100-240 V~	50-60 Hz	23	E27	2

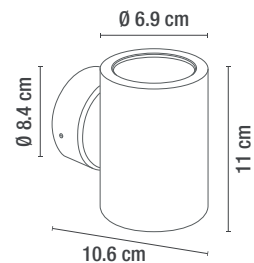

1120-LED/GF

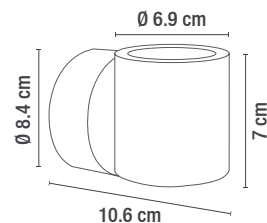

1220-LED/GR



CÓDIGO	DESCRIPCIÓN	APLICACIÓN	MATERIA PRIMA	TERMINADO	POTENCIA MÁX. (W)	VOLTAJE (RANGO)	WAC-Hz	IP	VIDA PROMEDIO (h)	ÁNGULO DE APERTURA	LUMENS (lm)	TEMPERATURA (K)
1120-LED/GF	LUMINARIA LED DE SOBREPONER PARA MURO	EXTERIOR	ALUMINIO / CRISTAL	GRAFITO	8 W	100-240 V~	50-60 Hz	54	30000 h	44°	575 lm	3 000 K
1220-LED/GR	LUMINARIA LED DE SOBREPONER PARA MURO	EXTERIOR	ALUMINIO / CRISTAL	GRIS GRAFITO	4 W	100-240 V~	50-60 Hz	54	30000 h	36°	302 lm	3 000 K

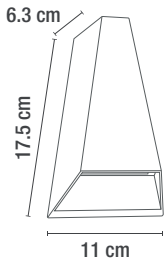

1620-LED/B

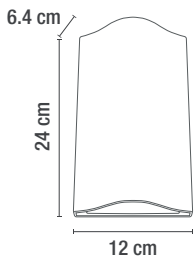

5520-LED



1620-LED/B

CÓDIGO	DESCRIPCIÓN	APLICACIÓN	MATERIA PRIMA	TERMINADO	POTENCIA MÁX. (W)	VOLTAJE (RANGO)	VAC-Hz	IP	VIDA PROMEDIO (h)	ÁNGULO DE APERTURA	LUMENS (lm)	TEMPERATURA (K)
1620-LED/B 1620-LED/GF 1620-LED/GR	LUMINARIA LED DE SOBREPONER PARA MURO	EXTERIOR	ALUMINIO / CRISTAL	BLANCO GRAFITO GRIS	6 W	100-240 V~	50-60 Hz	54	30000 h	83°	360 lm	3 000 K
5520-LED	LUMINARIA LED DE SOBREPONER PARA MURO	EXTERIOR	ALUMINIO / CRISTAL	GRAFITO	14 W	100-240 V~	50-60 Hz	54	30000 h	98°	990 lm	3 000 K



9520-LED

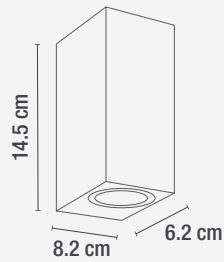

9520-LED/GF

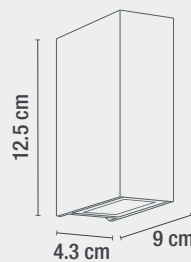

1720-LED/GF



CÓDIGO	DESCRIPCIÓN	APLICACIÓN	MATERIA PRIMA	TERMINADO	POTENCIA MÁX. (W)	VOLTAJE (RANGO)	VAR-Hz	IP	VIDA PROMEDIO (h)	ÁNGULO DE APERTURA	LUMENS (lm)	TEMPERATURA (K)
9520-LED/GF 9520-LED	LUMINARIA LED DE SOBREPONER PARA MURO	EXTERIOR	ALUMINIO / CRISTAL	GRAFITO GRIS	14 W	100-240 V~	50-60 Hz	54	30000 h	73°	1116 lm	3 000 K
1720-LED/GF 1720-LED/GR	LUMINARIA LED DE SOBREPONER PARA MURO	EXTERIOR	ALUMINIO / CRISTAL	GRAFITO GRIS	6 W	100-240 V~	50-60 Hz	54	30000 h	65°	360 lm	3 000 K



1020-LED/GF

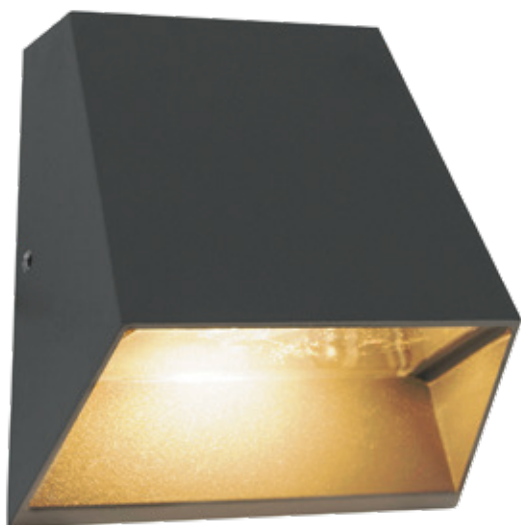
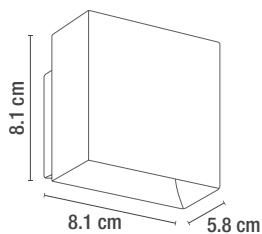

7420-LED

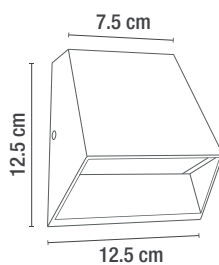

7420-LED



CÓDIGO	DESCRIPCIÓN	APLICACIÓN	MATERIA PRIMA	TERMINADO	POTENCIA MÁX. (W)	VOLTAJE (RANGO)	VAC-Hz	IP	VIDA PROMEDIO (h)	ÁNGULO DE APERTURA	LUMENS (lm)	TEMPERATURA (K)
1020-LED/GF	LUMINARIA LED DE SOBREPONER PARA MURO	EXTERIOR	ALUMINIO / POLICARBONATO	GRAFITO	7 W	100-130 V~	50-60 Hz	54	30000 h	93°	400 lm	3 000 K
7420-LED	LUMINARIA LED DE SOBREPONER PARA MURO	EXTERIOR	ALUMINIO / POLICARBONATO	GRAFITO	7 W	100-240 V~	50-60 Hz	54	30000 h	108°	389 lm	3 000 K

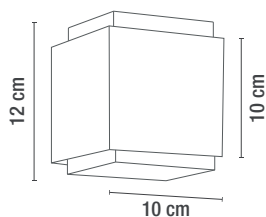

1025-LED/GF

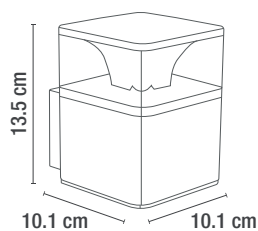

1026-LED/GF



CÓDIGO	DESCRIPCIÓN	APLICACIÓN	MATERIA PRIMA	TERMINADO	POTENCIA MÁX. (W)	VOLTAJE (RANGO)	VAC-Hz	IP	VIDA PROMEDIO (h)	ÁNGULO DE APERTURA	LUMENS (lm)	TEMPERATURA (K)
1025-LED/GF	LUMINARIA LED DE SOBREPONER PARA MURO	EXTERIOR	ALUMINIO / CRISTAL	GRAFITO	12 W	100-240 V~	50-60 Hz	54	25000 h	172°	170 lm	3 000 K
1026-LED/GF	LUMINARIA LED DE SOBREPONER PARA MURO	EXTERIOR	ALUMINIO / POLICARBONATO	GRAFITO	6 W	100-240 V~	50-60 Hz	65	30000 h	360°	389 lm	3 000 K

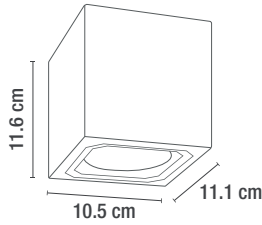

8620-LED/GF

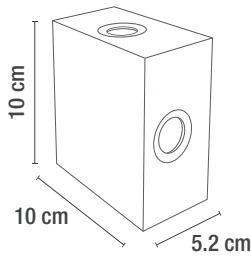

8720-LED/GF



CÓDIGO	DESCRIPCIÓN	APLICACIÓN	MATERIA PRIMA	TERMINADO	POTENCIA MÁX. (W)	VOLTAJE (RANGO)	VAC-Hz	IP	VIDA PROMEDIO (h)	ÁNGULO DE APERTURA	LUMENS (lm)	TEMPERATURA (K)
8620-LED/GF	LUMINARIA LED DE SOBREPONER PARA MURO	EXTERIOR	ALUMINIO / CRISTAL	GRAFITO	12 W	100-240 V~	50-60 Hz	54	30000 h	24°	1093 lm	3 000 K
8720-LED/GF	LUMINARIA LED DE SOBREPONER PARA MURO	EXTERIOR	ALUMINIO	GRAFITO	4 W	100-240 V~	50-60 Hz	54	30000 h	11°	321 lm	3 000 K



1027-LED/BL

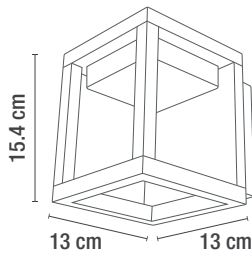

1027-LED/BL

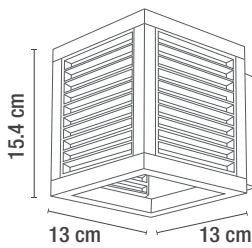

1028-LED/BL



CÓDIGO	DESCRIPCIÓN	APLICACIÓN	MATERIA PRIMA	TERMINADO	POTENCIA MÁX. (W)	VOLTAJE (RANGO)	VAC-Hz	IP	VIDA PROMEDIO (h)	ÁNGULO DE APERTURA	LUMENS (lm)	TEMPERATURA (K)
1027-LED/BL	LUMINARIA LED DE SOBREPONER PARA MURO	EXTERIOR	ALUMINIO	BLANCO	10 W	100-240 V~	50-60 Hz	54	30000 h	115°	946 lm	3 000 K
1028-LED/BL	LUMINARIA LED DE SOBREPONER PARA MURO	EXTERIOR	ALUMINIO	BLANCO	10 W	100-240 V~	50-60 Hz	54	30000 h	48°	576 lm	3 000 K

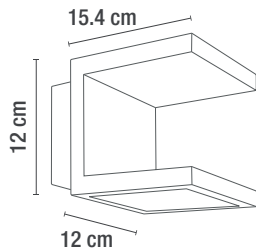

8820-LED

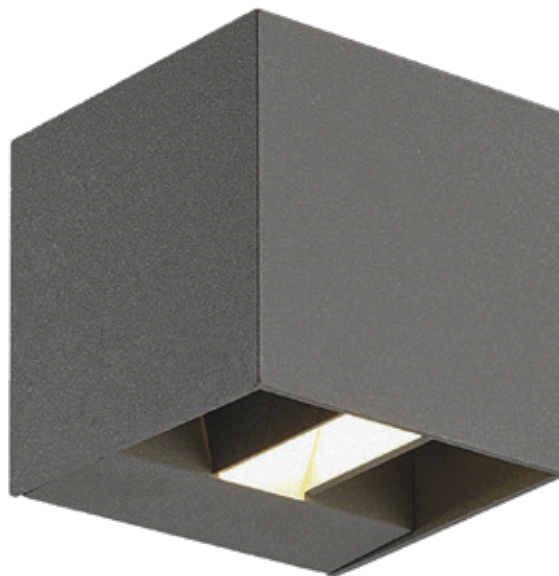
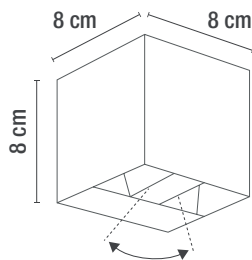

9620-LED



CÓDIGO	DESCRIPCIÓN	APLICACIÓN	MATERIA PRIMA	TERMINADO	POTENCIA MÁX. (W)	VOLTAJE (RANGO)	VAC-Hz	IP	VIDA PROMEDIO (h)	ÁNGULO DE APERTURA	LUMENS (lm)	TEMPERATURA (K)
8820-LED	LUMINARIA LED DE SOBREPONER PARA MURO	EXTERIOR	ALUMINIO / POLICARBONATO	GRAFITO	14 W	100-240 V~	50-60 Hz	54	30000 h	111°	900 lm	3 000 K
9620-LED	LUMINARIA LED DE SOBREPONER PARA MURO	EXTERIOR	ALUMINIO / POLICARBONATO	GRAFITO	6 W	100-240 V~	50-60 Hz	54	30000 h	30°-100°	360 lm	3 000 K

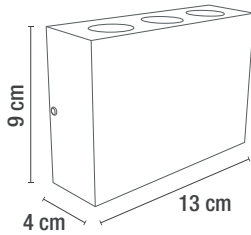

8320-LED/B

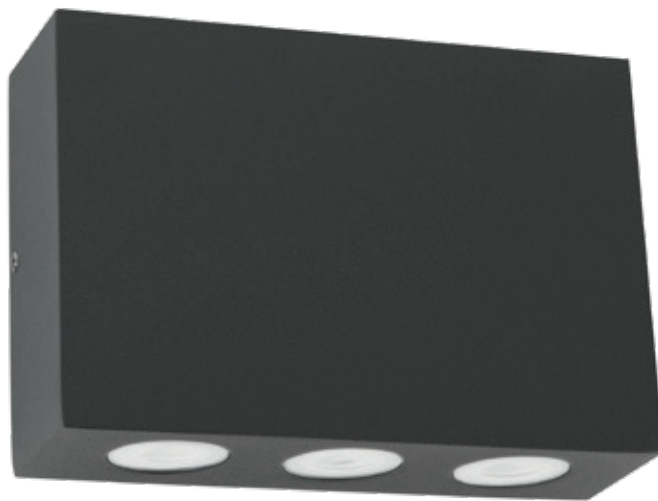
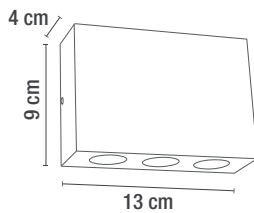

8420-LED/GF



CÓDIGO	DESCRIPCIÓN	APLICACIÓN	MATERIA PRIMA	TERMINADO	POTENCIA MÁX. (W)	VOLTAJE (RANGO)	VAC-Hz	IP	VIDA PROMEDIO (h)	ÁNGULO DE APERTURA	LUMENS (lm)	TEMPERATURA (K)
8320-LED/B 8320-LED/GF	LUMINARIA LED DE SOBREPONER PARA MURO	EXTERIOR	ALUMINIO	BLANCO GRAFITO	6 W	100-240 V~	50-60 Hz	54	30000 h	36°	438 lm	3 000 K
8420-LED/GF	LUMINARIA LED DE SOBREPONER PARA MURO	EXTERIOR	ALUMINIO	GRAFITO	3 W	100-240 V~	50-60 Hz	54	30000 h	36°	264 lm	3 000 K

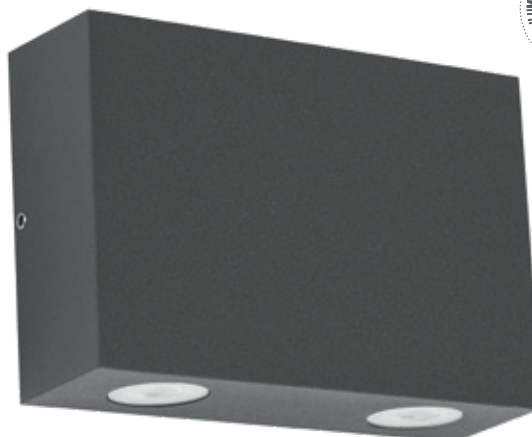
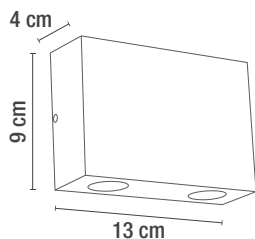

8520-LED

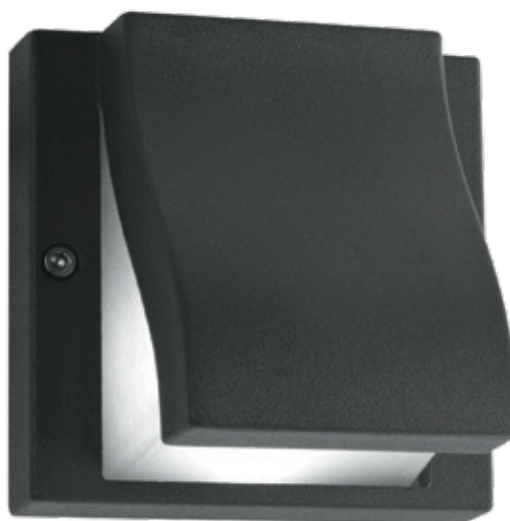
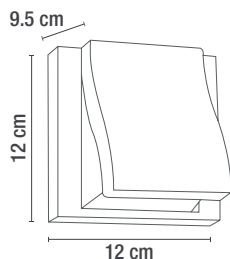

9420-LED/GF



CÓDIGO	DESCRIPCIÓN	APLICACIÓN	MATERIA PRIMA	TERMINADO	POTENCIA MÁX. (W)	VOLTAJE (RANGO)	VAR-Hz	IP	VIDA PROMEDIO (h)	ÁNGULO DE APERTURA	LUMENS (lm)	TEMPERATURA (K)
8520-LED	LUMINARIA LED DE SOBREPONER PARA MURO	EXTERIOR	ALUMINIO	GRAFITO	4 W	100-240 V~	50-60 Hz	54	30000 h	34°	327 lm	3 000 K
9420-LED/GF	LUMINARIA LED DE SOBREPONER PARA MURO	EXTERIOR	ALUMINIO	GRAFITO	3 W	100-240 V~	50-60 Hz	54	30000 h	52°	200 lm	3 000 K

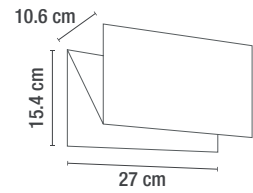

5720-LED/GF

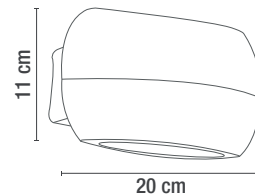

5721-LED/BL



CÓDIGO	DESCRIPCIÓN	APLICACIÓN	MATERIA PRIMA	TERMINADO	POTENCIA MÁX. (W)	VOLTAJE (RANGO)	VAC-Hz	IP	VIDA PROMEDIO (h)	ÁNGULO DE APERTURA	LUMENS (lm)	TEMPERATURA (K)
5720-LED/GF 5720-LED/BL	LUMINARIA LED DE SOBREPONER PARA MURO	EXTERIOR	ALUMINIO / CRISTAL	GRAFITO BLANCO	15 W	100-130 V~	50-60 Hz	54	30000 h	101°	1100 lm	3 000 K
5721-LED/BL	LUMINARIA LED DE SOBREPONER PARA MURO	EXTERIOR	ALUMINIO / POLICARBONATO	BLANCO	12 W	100-240 V~	50-60 Hz	54	25000 h	90°	610 lm	3 000 K

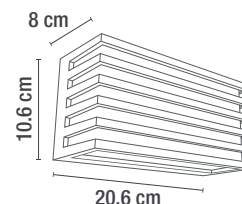
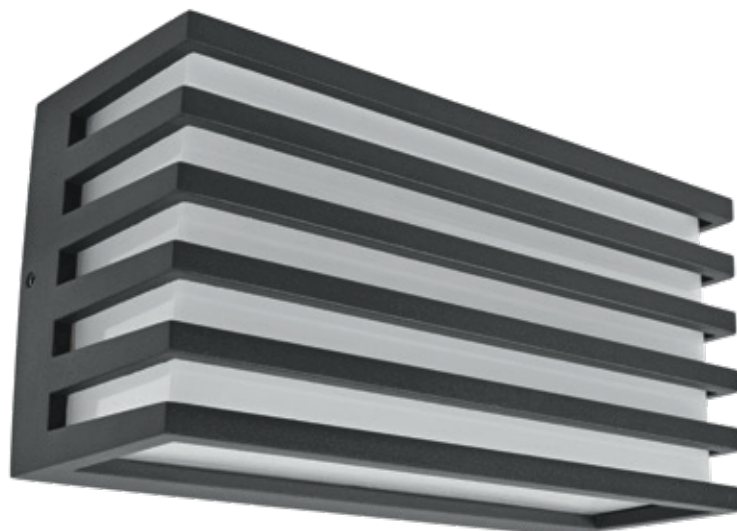

5225-LED/GF

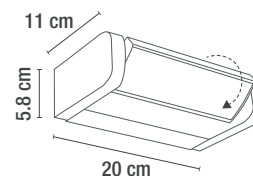

5226-LED/GF



CÓDIGO	DESCRIPCIÓN	APLICACIÓN	MATERIA PRIMA	TERMINADO	POTENCIA MÁX. (W)	VOLTAJE (RANGO)	VAC-Hz	IP	VIDA PROMEDIO (h)	ÁNGULO DE APERTURA	LUMENS (lm)	TEMPERATURA (K)
5225-LED/GF	LUMINARIA LED DE SOBREPONER PARA MURO	EXTERIOR	ALUMINIO / ACRÍLICO	GRAFITO	10 W	100-240 V~	50-60 Hz	65	30000 h	138°	315 lm	3 000 K
5226-LED/GF	LUMINARIA LED DIRIGIBLE DE SOBREPONER PARA MURO	EXTERIOR	ALUMINIO / PLÁSTICO	GRAFITO	6 W	100-240 V~	50-60 Hz	65	30000 h	350°	382 lm	3 000 K



3820-LED/GF

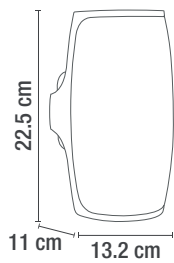

5320-LED/GF

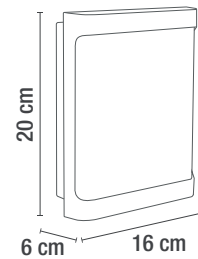

5220-LED/GF

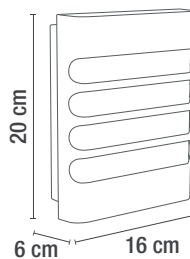

CÓDIGO	DESCRIPCIÓN	APLICACIÓN	MATERIA PRIMA	TERMINADO	POTENCIA MÁX. (W)	VOLTAJE (RANGO)	VAC-Hz	IP	VIDA PROMEDIO (h)	ÁNGULO DE APERTURA	LUMENS (lm)	TEMPERATURA (K)
3820-LED/GF	LUMINARIA LED DE SOBREPONER PARA MURO	EXTERIOR	ALUMINIO / POLICARBONATO	GRAFITO	12 W	100-240 V~	50-60 Hz	54	30000 h	120°	800 lm	3 000 K
5320-LED/GF	LUMINARIA LED DE SOBREPONER PARA MURO	EXTERIOR	ALUMINIO / POLICARBONATO	GRAFITO	10 W	100-240 V~	50-60 Hz	54	30000 h	120°	750 lm	3 000 K
5220-LED/GF	LUMINARIA LED DE SOBREPONER PARA MURO	EXTERIOR	ALUMINIO / POLICARBONATO	GRAFITO	10 W	100-240 V~	50-60 Hz	54	30000 h	120°	750 lm	3 000 K

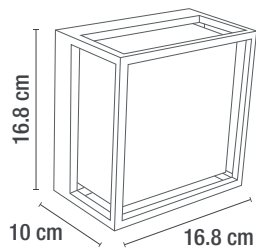

1640-LED/GF

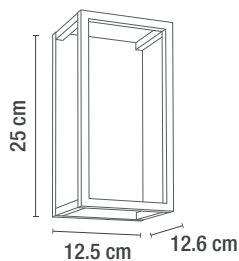

MU0905-LED/GF



CÓDIGO	DESCRIPCIÓN	APLICACIÓN	MATERIA PRIMA	TERMINADO	POTENCIA MÁX. (W)	VOLTAJE (RANGO)	VAC-Hz	IP	VIDA PROMEDIO (h)	ÁNGULO DE APERTURA	LUMENS (lm)	TEMPERATURA (K)
1640-LED/GF	LUMINARIA LED DE SOBREPONER PARA MURO	EXTERIOR	ALUMINIO / POLICARBONATO	GRAFITO	9 W	100-240 V~	50-60 Hz	54	30000 h	180°	720 lm	3 000 K
MU0905-LED/GF	LUMINARIA LED DE SOBREPONER PARA MURO	EXTERIOR	ALUMINIO / POLICARBONATO	GRAFITO	7 W	127 V~	50-60 Hz	54	30000 h	67°	212 lm	3 000 K

PRODUCTO
NUEVO

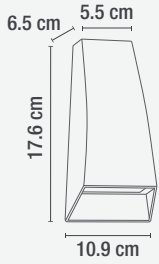

MU1612-LED/GF

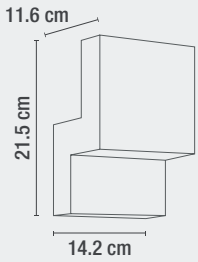

2920-LED

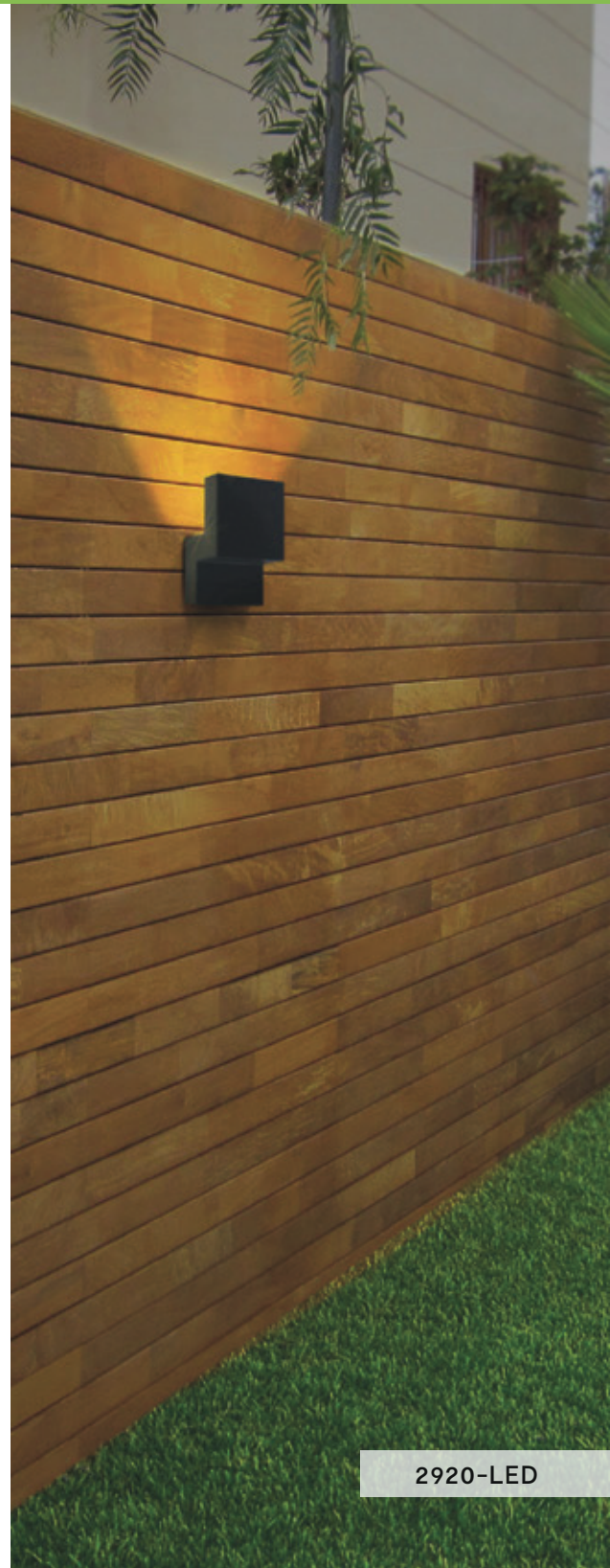

2920-LED

CÓDIGO	DESCRIPCIÓN	APLICACIÓN	MATERIA PRIMA	TERMINADO	POTENCIA MÁX. (W)	VOLTAJE (RANGO)	VAC-Hz	IP	VIDA PROMEDIO (h)	ÁNGULO DE APERTURA	LUMENS (lm)	TEMPERATURA (K)
MU1612-LED/GF	LUMINARIA LED DE SOBREPONER PARA MURO	EXTERIOR	ALUMINIO	GRAFITO	6 W	100-240 V~	50-60 Hz	54	25000 h	60°	460 lm	3 000 K
2920-LED	LUMINARIA LED DE SOBREPONER PARA MURO	EXTERIOR	ALUMINIO	GRAFITO	12 W	100-240 V~	50-60 Hz	54	30000 h	64°	800 lm	3 000 K



2520-LED/B



2520-LED/B

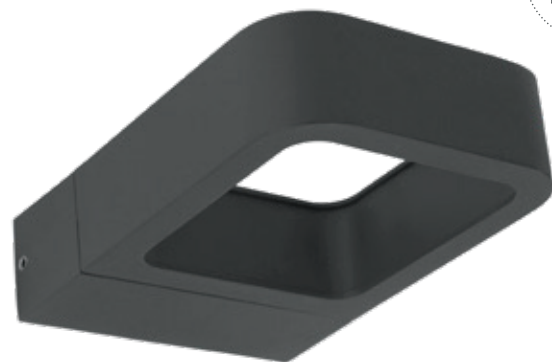
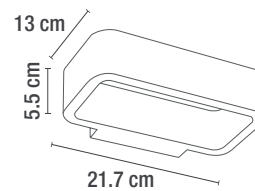

2820-LED

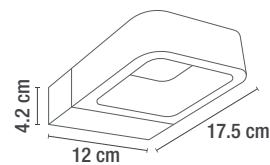

CÓDIGO	DESCRIPCIÓN	APLICACIÓN	MATERIA PRIMA	TERMINADO	POTENCIA MÁX. (W)	VOLTAJE (RANGO)	VAC-Hz	IP	VIDA PROMEDIO (h)	ÁNGULO DE APERTURA	LUMENS (lm)	TEMPERATURA (K)
2520-LED/B 2520-LED/GF 2520-LED	LUMINARIA LED DE SOBREPONER PARA MURO	EXTERIOR	ALUMINIO	BLANCO GRAFITO GRIS	7 W	100-240 V~	50-60 Hz	54	30000 h	126°	448 lm	3 000 K
2820-LED	LUMINARIA LED DE SOBREPONER PARA MURO	EXTERIOR	ALUMINIO	GRAFITO	7 W	100-240 V~	50-60 Hz	54	30000 h	160°	400 lm	3 000 K

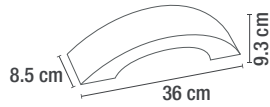

4320-LED

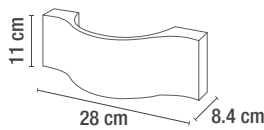

2620-LED

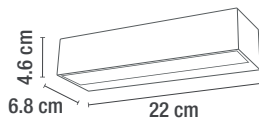

7820-LED/GF



CÓDIGO	DESCRIPCIÓN	APLICACIÓN	MATERIA PRIMA	TERMINADO	POTENCIA MÁX. (W)	VOLTAJE (RANGO)	VAC-Hz	IP	VIDA PROMEDIO (h)	ÁNGULO DE APERTURA	LUMENS (lm)	TEMPERATURA (K)
4320-LED	LUMINARIA LED DE SOBREPONER PARA MURO	EXTERIOR	ALUMINIO	GRIS	9 W	100-240 V~	50-60 Hz	54	30000 h	100°	600 lm	3 000 K
2620-LED	LUMINARIA LED DE SOBREPONER PARA MURO	EXTERIOR	ALUMINIO	GRAFITO	7 W	100-240 V~	50-60 Hz	54	30000 h	100°	457 lm	3 000 K
7820-LED/GF 7820-LED/BL	LUMINARIA LED DE SOBREPONER PARA MURO	EXTERIOR	ALUMINIO / CRISTAL	GRAFITO BLANCO	16 W	100-240 V~	50-60 Hz	54	30000 h	120°	1100 lm	3 000 K

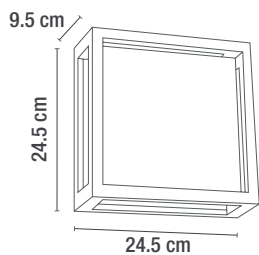

5466/GF

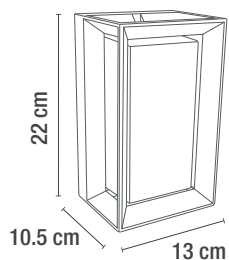

5491/GF



CÓDIGO	DESCRIPCIÓN	APLICACIÓN	MATERIA PRIMA	TERMINADO	POTENCIA MÁX. (W)	VOLTAJE (RANGO)	VAC-Hz	IP	TIPO DE SOCKET	No. DE SOCKET
5466/GF	LUMINARIA DE SOBREPONER EN MURO	EXTERIOR	ALUMINIO / CRISTAL	GRAFITO	80 W	127 V~	50-60 Hz	54	E27	2
5491/GF	LUMINARIA DE SOBREPONER EN MURO	EXTERIOR	ALUMINIO / POLICARBONATO	GRAFITO	60 W	127 V~	50-60 Hz	54	E27	1



5192/G

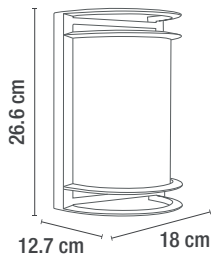

5194/G

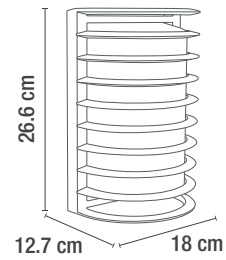

5462/GF

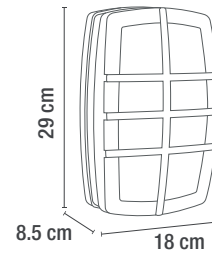

CÓDIGO	DESCRIPCIÓN	APLICACIÓN	MATERIA PRIMA	TERMINADO	POTENCIA MÁX. (W)	VOLTAJE (RANGO)	VAC-Hz	IP	TIPO DE SOCKET	No. DE SOCKET
5192/G 5192/N 5192/GF	LUMINARIA DE SOBREPONER EN MURO	EXTERIOR	ALUMINIO / CRISTAL	GRIS NEGRO GRAFITO	60 W	127 V~	50-60 Hz	44	E27	1
5194/G 5194/N	LUMINARIA DE SOBREPONER EN MURO	EXTERIOR	ALUMINIO / CRISTAL	GRIS NEGRO	60 W	127 V~	50-60 Hz	44	E27	1
5462/GF	LUMINARIA DE SOBREPONER EN MURO	EXTERIOR	ALUMINIO / POLICARBONATO	GRAFITO	80 W	127 V~	50-60 Hz	54	E27	2



8143

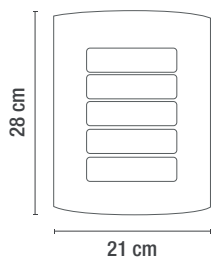

8144

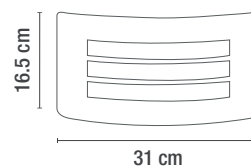

8148

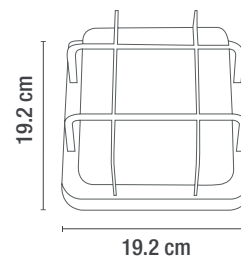

CÓDIGO	DESCRIPCIÓN	APLICACIÓN	MATERIA PRIMA	TERMINADO	POTENCIA MÁX. (W)	VOLTAJE (RANGO)	VAC-Hz	IP	TIPO DE SOCKET	No. DE SOCKET
8143	LUMINARIA DE SOBREPONER EN MURO	EXTERIOR	ACERO INOXIDABLE / POLICARBONATO	INOXIDABLE	60 W	127 V~	50-60 Hz	44	E27	1
8144	LUMINARIA DE SOBREPONER EN MURO	EXTERIOR	ACERO INOXIDABLE / POLICARBONATO	INOXIDABLE	40 W	100-240 V~	50-60 Hz	54	E27	1
8148	LUMINARIA DE SOBREPONER EN MURO	EXTERIOR	ACERO INOXIDABLE / CRISTAL	INOXIDABLE	60 W	100-240 V~	50-60 Hz	54	E27	1



2009-E27/GF

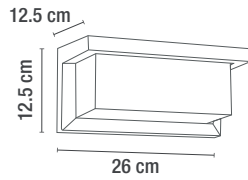

2012-E27/GF

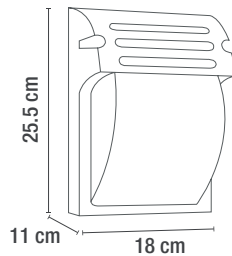

2009-E27/GF

CÓDIGO	DESCRIPCIÓN	APLICACIÓN	MATERIA PRIMA	TERMINADO	POTENCIA MÁX. (W)	VOLTAJE (RANGO)	VAC-Hz	IP	TIPO DE SOCKET	No. DE SOCKET
2009-E27/GF	LUMINARIA DE SOBREPONER EN MURO	EXTERIOR	ALUMINIO / POLICARBONATO	GRAFITO	60 W	100-240 V~	50-60 Hz	54	E27	1
2012-E27/GF	LUMINARIA DE SOBREPONER EN MURO	EXTERIOR	ALUMINIO / POLICARBONATO	GRAFITO	60 W	127 V~	50-60 Hz	54	E27	1



5471

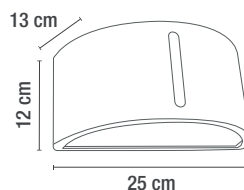

5464/GF

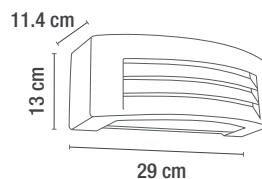

CÓDIGO	DESCRIPCIÓN	APLICACIÓN	MATERIA PRIMA	TERMINADO	POTENCIA MÁX. (W)	VOLTAJE (RANGO)	VAC-Hz	IP	TIPO DE SOCKET	No. DE SOCKET
5471	LUMINARIA DE SOBREPONER EN MURO	EXTERIOR	ALUMINIO / POLICARBONATO	GRAFITO	40 W	125 V~	50-60 Hz	54	E27	1
5464/GF	LUMINARIA DE SOBREPONER EN MURO	EXTERIOR	ALUMINIO / POLICARBONATO	GRAFITO	60 W	127 V~	50-60 Hz	54	E27	1



5481

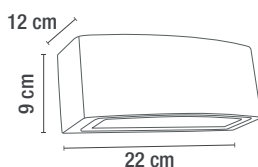

5482/BL

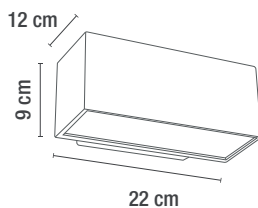

CÓDIGO	DESCRIPCIÓN	APLICACIÓN	MATERIA PRIMA	TERMINADO	POTENCIA MÁX. (W)	VOLTAJE (RANGO)	VAC-Hz	IP	TIPO DE SOCKET	No. DE SOCKET
5481 5481/BL	LUMINARIA DE SOBREPONER EN MURO	EXTERIOR	ALUMINIO / CRISTAL	GRAFITO BLANCO	60 W	127 V~	50-60 Hz	54	E27	1
5482/BL 5482/GF	LUMINARIA DE SOBREPONER EN MURO	EXTERIOR	ALUMINIO / CRISTAL	BLANCO GRAFITO	60 W	127 V~	50-60 Hz	54	E27	1



9268-GU10/GF

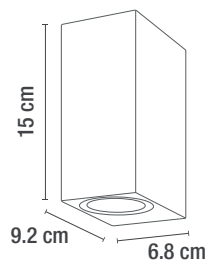

9281-GU10/GF

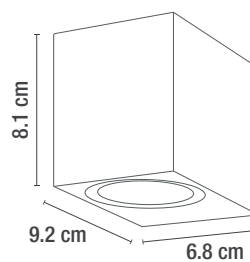

*ESTAS LUMINARIAS NO INCLUYEN LÁMPARA

CÓDIGO	DESCRIPCIÓN	APLICACIÓN	MATERIA PRIMA	TERMINADO	POTENCIA MÁX. (W)	VOLTAJE (RANGO)	VAC-Hz	IP	TIPO DE SOCKET	No. DE SOCKET
9268-GU10/GF 9268-GU10/BL	LUMINARIA DE SOBREPONER EN MURO	EXTERIOR	ALUMINIO	GRAFITO BLANCO	70 W	127 V~	50-60 Hz	44	GU10	2
9281-GU10/GF 9281-GU10/BL	LUMINARIA DE SOBREPONER EN MURO	EXTERIOR	ALUMINIO	GRAFITO BLANCO	35 W	127 V~	50-60 Hz	44	GU10	1



9270-GU10/GF

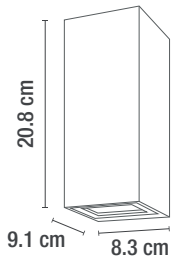

9272-GU10/GF

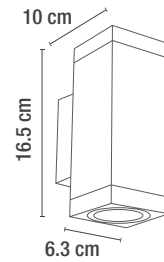

9274-GU10/BL

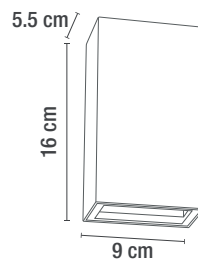

CÓDIGO	DESCRIPCIÓN	APLICACIÓN	MATERIA PRIMA	TERMINADO	POTENCIA MÁX. (W)	VOLTAJE (RANGO)	VAC-Hz	IP	TIPO DE SOCKET	No. DE SOCKET
9270-GU10/GF 9270-GU10/BL	LUMINARIA DE SOBREPONER EN MURO	EXTERIOR	ALUMINIO	GRAFITO BLANCO	70 W	100-240 V~	50-60 Hz	54	GU10	2
9272-GU10/GF	LUMINARIA DE SOBREPONER EN MURO	EXTERIOR	ALUMINIO	GRAFITO	70 W	127 V~	50-60 Hz	54	GU10	2
9274-GU10/BL 9274-GU10/GF	LUMINARIA DE SOBREPONER EN MURO	EXTERIOR	ALUMINIO	BLANCO GRAFITO	70 W	127 V~	50-60 Hz	54	GU10	2



9271-GU10/BL

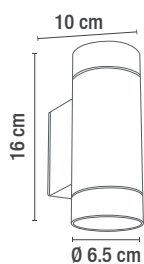

9283-GU10/GF

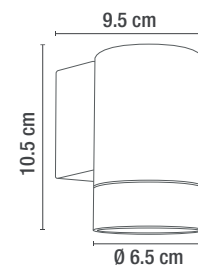

CÓDIGO	DESCRIPCIÓN	APLICACIÓN	MATERIA PRIMA	TERMINADO	POTENCIA MÁX. (W)	VOLTAJE (RANGO) VAC-Hz	IP	TIPO DE SOCKET	No. DE SOCKET
9271-GU10/BL 9271-GU10/GF	LUMINARIA DE SOBREPONER EN MURO	EXTERIOR	ALUMINIO / CRISTAL	BLANCO	70 W	127 V~ 50-60 Hz	54	GU10	2
9283-GU10/GF 9283-GU10/BL	LUMINARIA DE SOBREPONER EN MURO	EXTERIOR	ALUMINIO / CRISTAL	GRAFITO	35 W	127 V~ 50-60 Hz	54	GU10	1



6315-GU10/GF

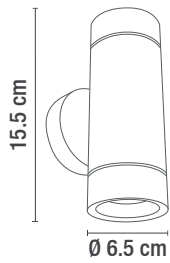

6316-GU10/GF

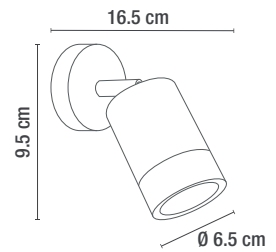

6363-GU10/GF

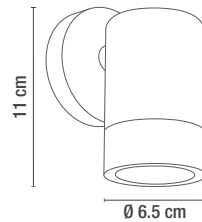

CÓDIGO	DESCRIPCIÓN	APLICACIÓN	MATERIA PRIMA	TERMINADO	POTENCIA MÁX. (W)	VOLTAJE (RANGO)	VAC-Hz	IP	TIPO DE SOCKET	No. DE SOCKET
6315-GU10/GF	LUMINARIA DE SOBREPONER EN MURO	EXTERIOR	ALUMINIO / CRISTAL	GRAFITO	70 W	127 V~	50-60 Hz	54	GU10	2
6316-GU10/GF	LUMINARIA DE SOBREPONER EN MURO	EXTERIOR	ALUMINIO / CRISTAL	GRAFITO	35 W	100-240 V~	50-60 Hz	54	GU10	1
6363-GU10/GF	LUMINARIA DE SOBREPONER EN MURO	EXTERIOR	ALUMINIO / CRISTAL	GRAFITO	35 W	127 V~	50-60 Hz	54	GU10	1



7031-A

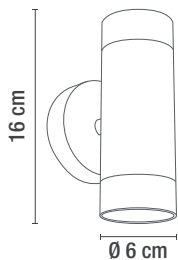

7033-A

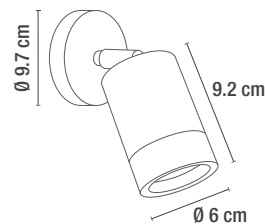

7032-A

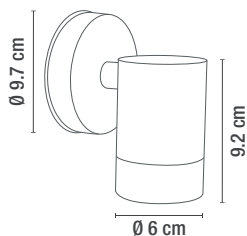

CÓDIGO	DESCRIPCIÓN	APLICACIÓN	MATERIA PRIMA	TERMINADO	POTENCIA MÁX. (W)	VOLTAJE (RANGO)	VAC-Hz	IP	TIPO DE SOCKET	No. DE SOCKET
7031-A	LUMINARIA DE SOBREPONER EN MURO	EXTERIOR	ACERO INOX / CRISTAL	INOXIDABLE	70 W	127 V~	50-60 Hz	54	GU10	2
7033-A	LUMINARIA DE SOBREPONER EN MURO	EXTERIOR	ACERO INOX / CRISTAL	INOXIDABLE	35 W	127 V~	50-60 Hz	54	GU10	1
7032-A	LUMINARIA DE SOBREPONER EN MURO	EXTERIOR	ACERO INOX / CRISTAL	INOXIDABLE	35 W	127 V~	50-60 Hz	54	GU10	1



3015-GU10/GF

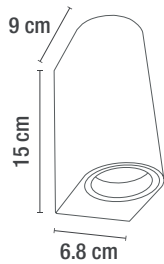

3081-GU10/GF

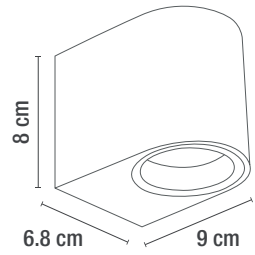

MU0102/NE

*POLICARBONATO

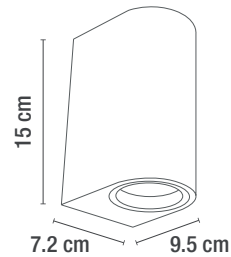

CÓDIGO	DESCRIPCIÓN	APLICACIÓN	MATERIA PRIMA	TERMINADO	POTENCIA MÁX. (W)	VOLTAJE (RANGO)	VAC-Hz	IP	TIPO DE SOCKET	No. DE SOCKET
3015-GU10/GF	LUMINARIA DE SOBREPONER EN MURO	EXTERIOR	ALUMINIO / CRISTAL	GRAFITO	70 W	127 V~	50-60 Hz	44	GU10	2
3081-GU10/GF	LUMINARIA DE SOBREPONER EN MURO	EXTERIOR	ALUMINIO / CRISTAL	GRAFITO	35 W	127 V~	50-60 Hz	44	GU10	1
MU0102/NE	LUMINARIA DE SOBREPONER EN MURO	EXTERIOR	PLASTICO / POLICARBONATO	NEGRO	10 W	127 V~	50-60 Hz	65	GU10	2



9273-GU10/GF

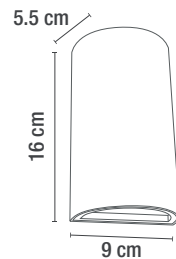

9273-GU10/GF

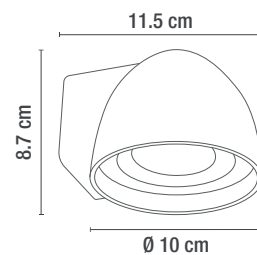

9282-GU10/GF



CÓDIGO	DESCRIPCIÓN	APLICACIÓN	MATERIA PRIMA	TERMINADO	POTENCIA MÁX. (W)	VOLTAJE (RANGO)	VAC-Hz	IP	TIPO DE SOCKET	No. DE SOCKET
9273-GU10/GF	LUMINARIA DE SOBREPONER EN MURO	EXTERIOR	ALUMINIO / CRISTAL	GRAFITO	70 W	127 V~	50-60 Hz	54	GU10	2
9282-GU10/GF	LUMINARIA DE SOBREPONER EN MURO	EXTERIOR	ALUMINIO / CRISTAL	GRAFITO	35 W	100-240 V~	50-60 Hz	54	GU10	1



2011-GU10/GF

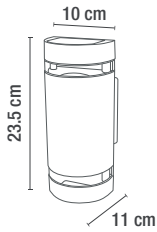

2013-GU10/GF

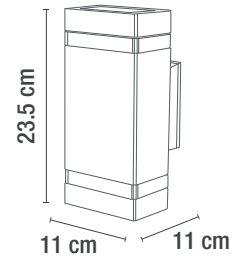

3082-GU10/GF

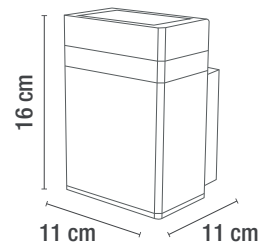

CÓDIGO	DESCRIPCIÓN	APLICACIÓN	MATERIA PRIMA	TERMINADO	POTENCIA MÁX. (W)	VOLTAJE (RANG)	VAC-Hz	IP	TIPO DE SOCKET	No. DE SOCKET
2011-GU10/GF	LUMINARIA DE SOBREPONER EN MURO	EXTERIOR	ALUMINIO / POLICARBONATO	GRAFITO	70 W	100-240 V~	50-60 Hz	54	GU10	2
2013-GU10/GF	LUMINARIA DE SOBREPONER EN MURO	EXTERIOR	ALUMINIO / POLICARBONATO	GRAFITO	70 W	100-240 V~	50-60 Hz	54	GU10	2
3082-GU10/GF	LUMINARIA DE SOBREPONER EN MURO	EXTERIOR	ALUMINIO / POLICARBONATO	GRAFITO	35 W	100-240 V~	50-60 Hz	54	GU10	1



MU0306/GF

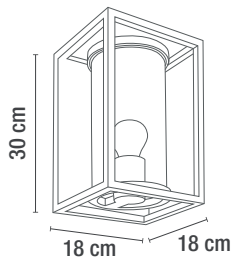

MU0408/GF

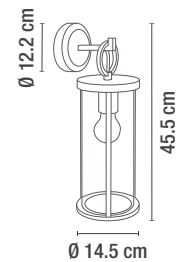

*ESTAS LUMINARIAS NO INCLUYEN LÁMPARA

CÓDIGO	DESCRIPCIÓN	APLICACIÓN	MATERIA PRIMA	TERMINADO	POTENCIA MÁX. (W)	VOLTAJE (RANGO)	VAC-Hz	IP	TIPO DE SOCKET	No. DE SOCKET
MU0306/GF	LUMINARIA DE SOBREPONER EN MURO	EXTERIOR	ALUMINIO / CRISTAL	GRAFITO	15 W	127 V~	50-60 Hz	54	E27	1
MU0408/GF	LUMINARIA DE SOBREPONER EN MURO	EXTERIOR	ALUMINIO / CRISTAL	GRAFITO	15 W	127 V~	50-60 Hz	54	E27	1



8373S-E27/GF

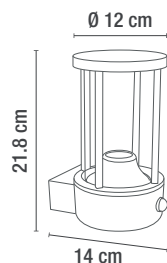

8372/GF

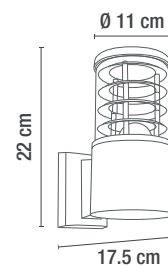

CÓDIGO	DESCRIPCIÓN	APLICACIÓN	MATERIA PRIMA	TERMINADO	POTENCIA MÁX. (W)	VOLTAJE (RANG)	VAC-Hz	IP	TIPO DE SOCKET	No. DE SOCKET
8373S-E27/GF	LUMINARIA DE SOBREPONER EN MURO CON SENSOR	EXTERIOR	ALUMINIO / CRISTAL	GRAFITO	15 W	127 V~	50-60 Hz	54	E27	1
8372/GF	LUMINARIA DE SOBREPONER EN MURO	EXTERIOR	ALUMINIO / CRISTAL	GRAFITO	15 W	127 V~	50-60 Hz	54	E27	1

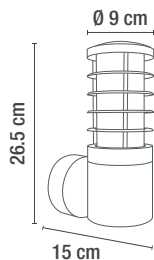

8362

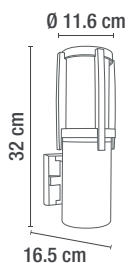

8382



CÓDIGO	DESCRIPCIÓN	APLICACIÓN	MATERIA PRIMA	TERMINADO	POTENCIA MÁX. (W)	VOLTAJE (RANGO)	VAC-Hz	IP	TIPO DE SOCKET	No. DE SOCKET
8362	LUMINARIA DE SOBREPONER EN MURO	EXTERIOR	ALUMINIO / CRISTAL	GRAFITO	20 W	100-240 V~	50-60 Hz	54	E27	1
8382	LUMINARIA DE SOBREPONER EN MURO	EXTERIOR	ALUMINIO / CRISTAL	GRAFITO	20 W	100-240 V~	50-60 Hz	54	E27	1



8112

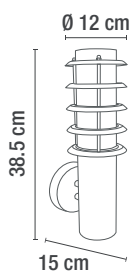

8102

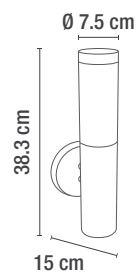

CÓDIGO	DESCRIPCIÓN	APLICACIÓN	MATERIA PRIMA	TERMINADO	POTENCIA MÁX. (W)	VOLTAJE (RANG)	VAC-Hz	IP	TIPO DE SOCKET	No. DE SOCKET
8112	LUMINARIA DE SOBREPONER EN MURO	EXTERIOR	ACERO INOXIDABLE / POLICARBONATO	INOXIDABLE	20 W	127 V~	50-60 Hz	54	E27	1
8102	LUMINARIA DE SOBREPONER EN MURO	EXTERIOR	ACERO INOXIDABLE / POLICARBONATO	INOXIDABLE	20 W	100-240 V~	50-60 Hz	54	E27	1



8146

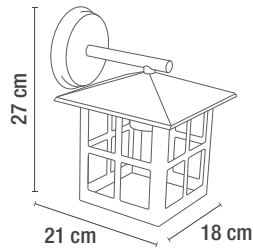

8146

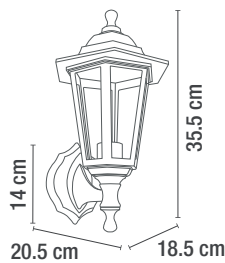

7040



CÓDIGO	DESCRIPCIÓN	APLICACIÓN	MATERIA PRIMA	TERMINADO	POTENCIA MÁX. (W)	VOLTAJE (RANGO)	VAC-Hz	IP	TIPO DE SOCKET	No. DE SOCKET
8146	LUMINARIA FAROL DE SOBREPONER EN MURO	EXTERIOR	ACERO INOXIDABLE / CRISTAL	INOXIDABLE	60 W	100-240 V~	50-60 Hz	44	E27	1
7040	LUMINARIA FAROL DE SOBREPONER EN MURO	EXTERIOR	POLIPROPILENO / CRISTAL	NEGRO	60 W	100-240 V~	50-60 Hz	54	E27	1



6042/GF

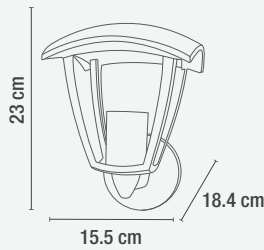

6043/GF

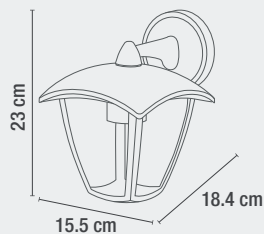

6042/GF

CÓDIGO	DESCRIPCIÓN	APLICACIÓN	MATERIA PRIMA	TERMINADO	POTENCIA MÁX. (W)	VOLTAJE (RANG)	VAC-Hz	IP	TIPO DE SOCKET	No. DE SOCKET
6042/GF	LUMINARIA FAROL DE SOBREPONER EN MURO	EXTERIOR	ALUMINIO / ACRÍLICO	GRAFITO	40 W	100-240 V~	50-60 Hz	44	E27	1
6043/GF 6043/NE	LUMINARIA FAROL DE SOBREPONER EN MURO	EXTERIOR	ALUMINIO / ACRÍLICO	GRAFITO NEGRO	40 W	100-240 V~	50-60 Hz	44	E27	1



6041/O

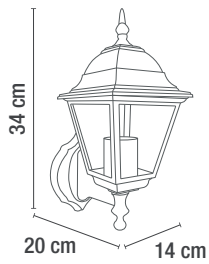

Hecho en México

1501N

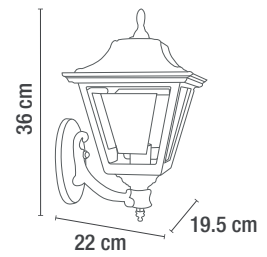

Hecho en México

1601N



CÓDIGO	DESCRIPCIÓN	APLICACIÓN	MATERIA PRIMA	TERMINADO	POTENCIA MÁX. (W)	VOLTAJE (RANGO)	VAC-Hz	IP	TIPO DE SOCKET	No. DE SOCKET
6041/O 6041/N	LUMINARIA FAROL DE SOBREPONER EN MURO	EXTERIOR	ALUMINIO / CRISTAL	ÓXIDO NEGRO	60 W	100-240 V~	50-60 Hz	54	E27	1
1501N	LUMINARIA FAROL DE SOBREPONER EN MURO	EXTERIOR	ALUMINIO / CRISTAL	NEGRO	60 W	125 V~	50-60 Hz	54	E27	1
1601N	LUMINARIA FAROL DE SOBREPONER EN MURO	EXTERIOR	ALUMINIO / CRISTAL	NEGRO	60 W	125 V~	50-60 Hz	54	E27	1



6502

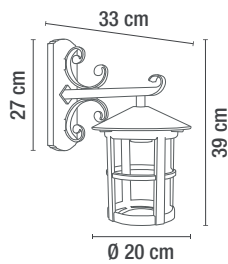

6512

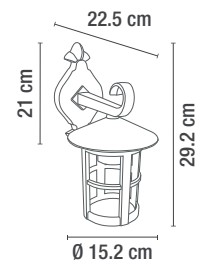

CÓDIGO	DESCRIPCIÓN	APLICACIÓN	MATERIA PRIMA	TERMINADO	POTENCIA MÁX. (W)	VOLTAJE (RANGO)	VAC-Hz	IP	TIPO DE SOCKET	No. DE SOCKET
6502	LUMINARIA FAROL DE SOBREPONER EN MURO	EXTERIOR	ALUMINIO / CRISTAL	ÓXIDO	60 W	127 V~	50-60 Hz	54	E27	1
6512	LUMINARIA FAROL DE SOBREPONER EN MURO	EXTERIOR	ALUMINIO / CRISTAL	ÓXIDO	60 W	127 V~	50-60 Hz	54	E27	1



4542

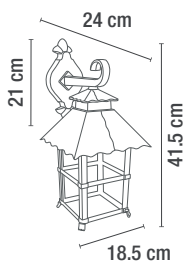

6501

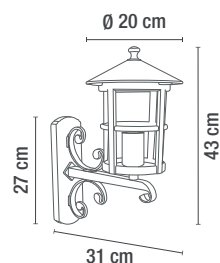

CÓDIGO	DESCRIPCIÓN	APLICACIÓN	MATERIA PRIMA	TERMINADO	POTENCIA MÁX. (W)	VOLTAJE (RANGO)	VAC-Hz	IP	TIPO DE SOCKET	No. DE SOCKET
4542	LUMINARIA FAROL DE SOBREPONER EN MURO	EXTERIOR	ALUMINIO / CRISTAL	ÓXIDO	60 W	127 V~	50-60 Hz	44	E27	1
6501	LUMINARIA FAROL DE SOBREPONER EN MURO	EXTERIOR	ALUMINIO / CRISTAL	ÓXIDO	60 W	127 V~	50-60 Hz	54	E27	1

Hecho en México



Hecho en México

BC6/BL

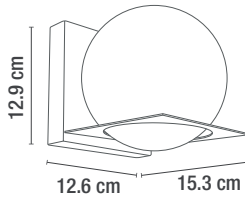

AM6N

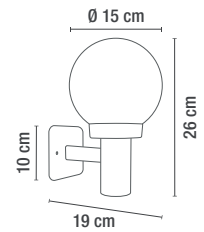

Hecho en México

DRA/N

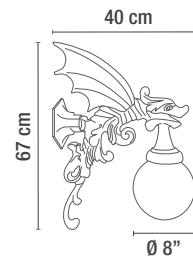

CÓDIGO	DESCRIPCIÓN	APLICACIÓN	MATERIA PRIMA	TERMINADO	POTENCIA MÁX. (W)	VOLTAJE (RANGO)	VAC-Hz	IP	TIPO DE SOCKET	No. DE SOCKET
BC6/BL BC6/N	LUMINARIA FAROL DE SOBREPONER EN MURO	EXTERIOR	ACERO / CRISTAL OPALINO / PMMA	BLANCO NEGRO	60 W	125 V~	50-60 Hz	54	E27	1
AM6N AM6B	LUMINARIA FAROL DE SOBREPONER EN MURO	EXTERIOR	ACERO / CRISTAL OPALINO / PMMA	NEGRO BLANCO	60 W	125 V~	50-60 Hz	54	E27	1
DRA/N	LUMINARIA FAROL DE SOBREPONER EN MURO	EXTERIOR	ALUMINIO FUNDIDO / CRISTAL OPALINO / PMMA	NEGRO	60 W	125 V~	50-60 Hz	54	E27	1



S6061-LED

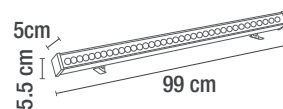

CL-2000S-LED/BL

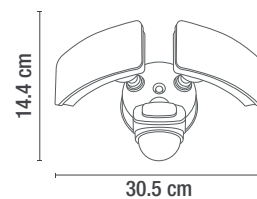

CÓDIGO	DESCRIPCIÓN	APLICACIÓN	MATERIA PRIMA	TERMINADO	POTENCIA MÁX. (W)	VOLTAJE (RANGO)	VAC-Hz	IP	VIDA PROMEDIO (h)	ÁNGULO DE APERTURA	LUMENS (lm)	IRC (CRI)	TEMPERATURA (K)
S6061-LED	LUMINARIA LED PARA BAÑAR MURO	EXTERIOR	ALUMINIO / CRISTAL	ALUMINIO	36 W	100-240 V~	50-60 Hz	54	30000 h	30°	2200 lm	80	3 000 K
CL-2000S-LED/BL	LUMINARIA REFLECTOR LED DIRIGIBLE CON SENSOR PARA MURO	EXTERIOR	POLICARBONATO	BLANCO	24 W	100-240 V~	50-60 Hz	65	15000 h	100°	2200 lm	80	4 100 K

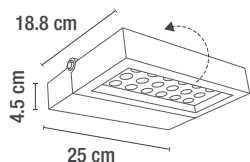

3020-LED

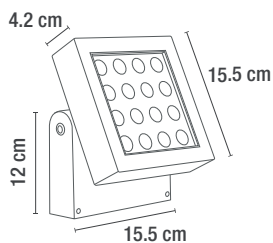

3021-LED



CÓDIGO	DESCRIPCIÓN	APLICACIÓN	MATERIA PRIMA	TERMINADO	POTENCIA MÁX. (W)	VOLTAJE (RANGO)	VAC-Hz	IP	VIDA PROMEDIO (h)	ÁNGULO DE APERTURA	LUMENS (lm)	IRC (CRI)	TEMPERATURA (K)
3020-LED	LUMINARIA REFLECTOR LED DIRIGIBLE PARA SOBREPONER EN TECHO, MURO O PISO	EXTERIOR	ALUMINIO / CRISTAL	GRAFITO	36 W	100-240 V~ 50-60 Hz	65	30000 h	28°	1964 lm	80	3 000 K	
3021-LED	LUMINARIA REFLECTOR LED DIRIGIBLE PARA SOBREPONER EN TECHO, MURO O PISO	EXTERIOR	ALUMINIO / CRISTAL	GRAFITO	16 W	100-240 V~ 50-60 Hz	65	30000 h	45°	1001 lm	80	3 000 K	

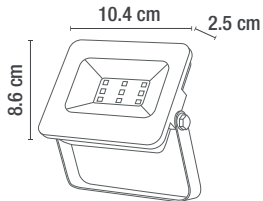

RF-3522-LED

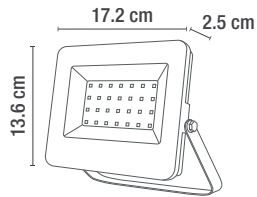

RF-3524-LED



CÓDIGO	DESCRIPCIÓN	APLICACIÓN	MATERIA PRIMA	TERMINADO	POTENCIA MÁX. (W)	VOLTAJE (RANGO)	VAC-Hz	IP	VIDA PROMEDIO (h)	ÁNGULO DE APERTURA	LUMENS (lm)	IRC (CRI)	TEMPERATURA (K)
RF-3522-LED	LUMINARIA REFLECTOR LED DIRIGIBLE PARA SOBREPONER EN TECHO, MURO O PISO	EXTERIOR	ALUMINIO / CRISTAL	NEGRO	10 W	100-240V~	50-60 Hz	65	30000 h	110°	880 lm	70	4 000 K
RF-3524-LED	LUMINARIA REFLECTOR LED DIRIGIBLE PARA SOBREPONER EN TECHO, MURO O PISO	EXTERIOR	ALUMINIO / CRISTAL	NEGRO	30 W	100-240V~	50-60 Hz	65	30000 h	110°	2743 lm	70	4 000 K

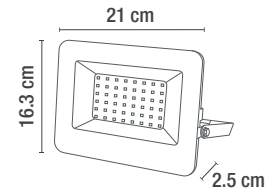

RF-3526-LED

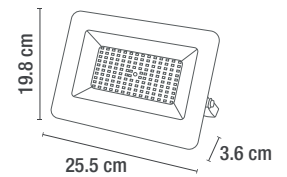

RF-3528-LED



CÓDIGO	DESCRIPCIÓN	APLICACIÓN	MATERIA PRIMA	TERMINADO	POTENCIA MÁX. (W)	VOLTAJE (RANGO)	VAC-Hz	IP	VIDA PROMEDIO (h)	ÁNGULO DE APERTURA	LUMENS (lm)	IRC (CRI)	TEMPERATURA (K)
RF-3526-LED	LUMINARIA REFLECTOR LED DIRIGIBLE PARA SOBREPONER EN TECHO, MURO O PISO	EXTERIOR	ALUMINIO / CRISTAL	NEGRO	50 W	100-240V~	50-60 Hz	65	30000 h	110°	4436 lm	70	4 000 K
RF-3528-LED	LUMINARIA REFLECTOR LED DIRIGIBLE PARA SOBREPONER EN TECHO, MURO O PISO	EXTERIOR	ALUMINIO / CRISTAL	NEGRO	100 W	100-240 V~	50-60 Hz	65	20000 h	110°	8500 lm	70	4 000 K

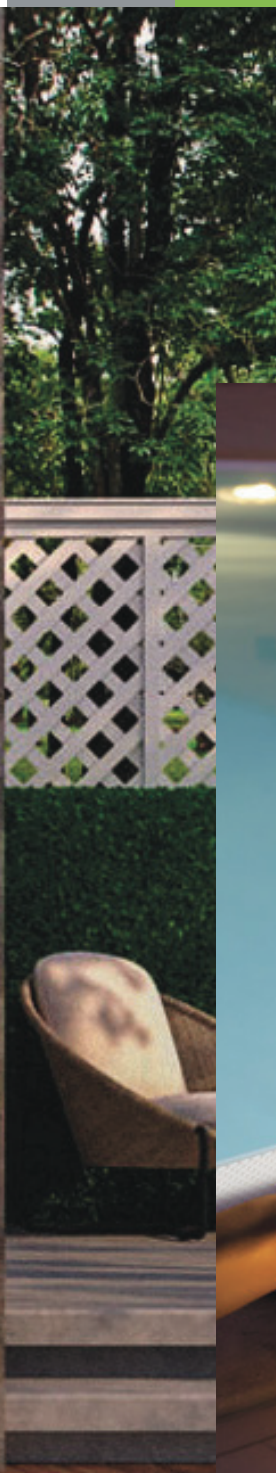



- 177 Empotrados LED
- 183 Empotrados
- 186 Estacas LED
- 187 Estacas
- 188 Minipostes LED
- 192 Minipostes
- 194 Postes y faroles
- 195 Postes

Línea de piso

174



PARA UNA INSTALACIÓN RÁPIDA Y SEGURA

Conector para conexión de cable eléctrico, evita el ingreso de agua a los cables de las **luminarias en exterior**.

* IP68

*Fácil de instalar, no es necesario fijarlo con tornillos.

*Carcasa resistente al fuego, segura y fácil de usar.

*Aplicable a la fuente de alimentación, red, equipo de comunicación, iluminación, etc.



ACCEDE A NUESTRO VIDEO TUTORIAL SOBRE LA INSTALACIÓN DE ESTE CONECTOR



CÓDIGO	DESCRIPCIÓN	APLICACIÓN	MATERIA PRIMA	TERMINADO	POTENCIA MÁX. (W)	VOLTAJE (RANGO)	VAC-HZ	IP
CX68	CONECTOR	EXTERIOR	PLÁSTICO	NEGRO	NA	450 V~	50-60 Hz	68

Luminarias de Piso

Nuestra línea de luminarias de piso cumple con las más altas exigencias en cuanto a funcionalidad y diseño que se adaptan a las diferentes técnicas de iluminación que terminan en un efecto decorativo. Enfatizar los espacios exteriores y jardines para resaltar el diseño paisajista se convierte en un arte.



7650-LED/GF

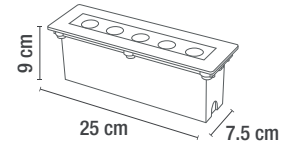

6220-LED/GF

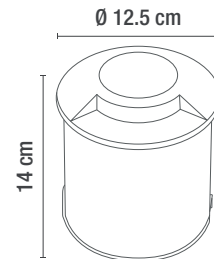

CÓDIGO	DESCRIPCIÓN	APLICACIÓN	MATERIA PRIMA	TERMINADO	POTENCIA MÁX. (W)	VOLTAJE (RANGO)	VAC-HZ	IP	VIDA PROMEDIO (h)	ÁNGULO DE APERTURA	LUMENS	IRC	TEMPERATURA	CORTE DE EMPOTRAMIENTO
7650-LED/GF	LUMINARIA LED PARA EMPOTRAR EN PISO PARA BAÑAR MURO	EXTERIOR	ALUMINIO / CRISTAL	GRAFITO	5 W	127 V~	50-60 Hz	67	50000 h	30°	448 lm	N/A	3000 K	Ø 25 x 7.5 cm
6220-LED/GF	LUMINARIA LED PARA EMPOTRAR EN PISO	EXTERIOR	ALUMINIO / POLICARBONATO	GRAFITO	7 W	127 V~	50-60 Hz	67	50000 h	110°	67 lm	N/A	3000 K	Ø 12.5 x 11.6 cm

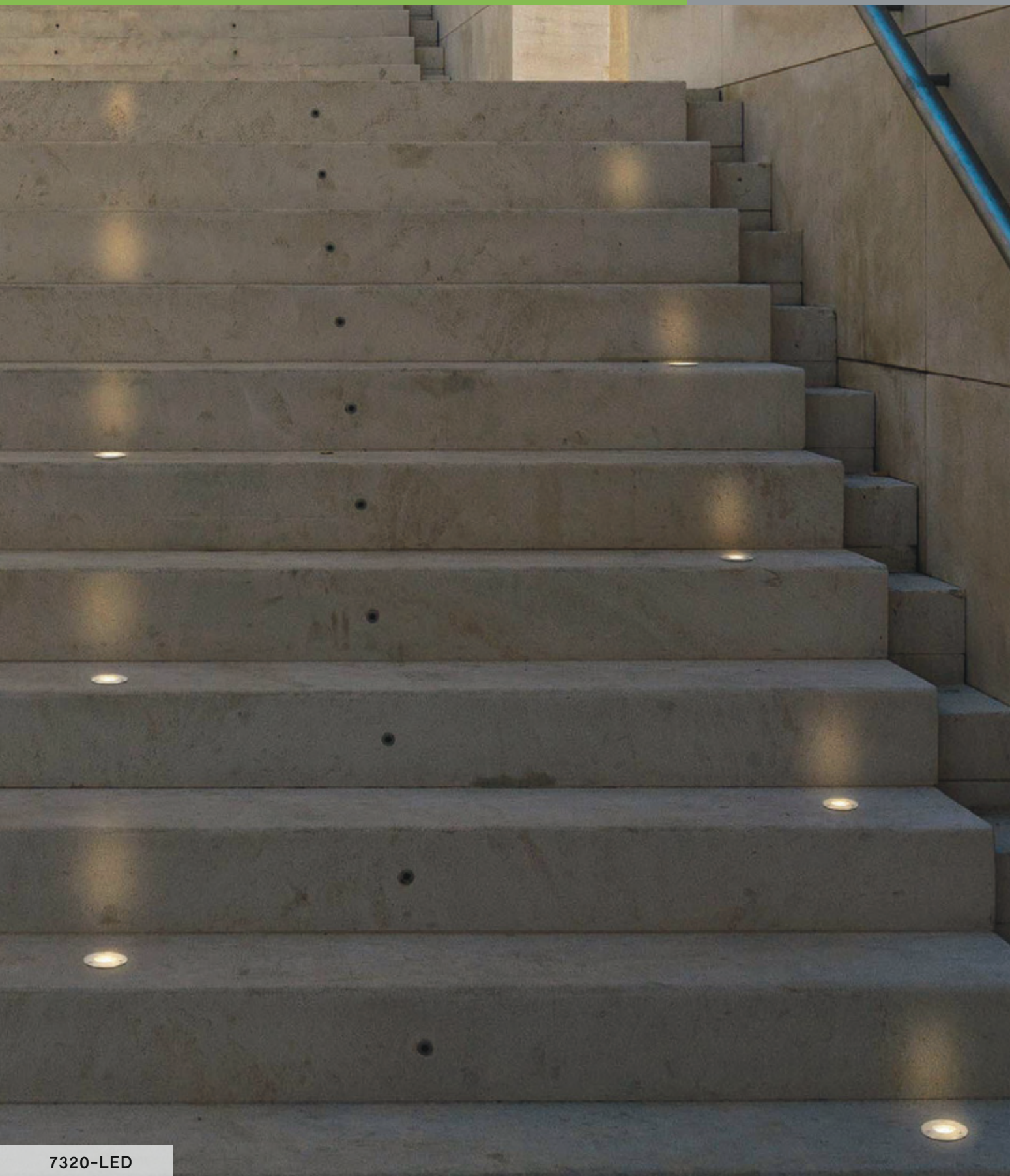

7320-LED



7320-LED

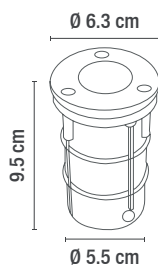

7020-LED

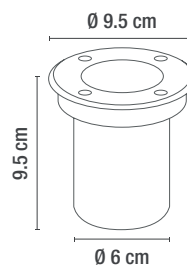

CÓDIGO	DESCRIPCIÓN	APLICACIÓN	MATERIA PRIMA	TERMINADO	POTENCIA MÁX. (W)	VOLTAJE (RANGO)	VAC-HZ	IP	VIDA PROMEDIO (h)	ÁNGULO DE APERTURA	LUMENS	IRC	TEMPERATURA	CORTE DE EMPOTRAMIENTO
7320-LED	LUMINARIA LED PARA EMPOTRAR EN PISO	EXTERIOR	ACERO INOX / CRISTAL	INOXIDABLE	0.8 W	100-240 V~	50-60 Hz	65	30000 h	74°	40 lm	80	3 000 K	Ø 5.9 cm
7020-LED	LUMINARIA LED PARA EMPOTRAR EN PISO	EXTERIOR	ACERO INOX / CRISTAL	ACERO INOXIDABLE	1.2 W	100-240 V~	50-60 Hz	54	30000 h	80°	40 lm	80	3 000 K	Ø 8.8 cm



8120-LED

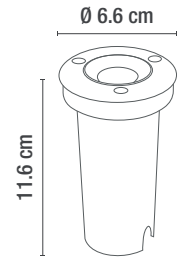

8120-LED

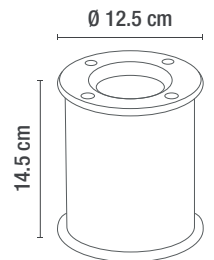

7120-LED



CÓDIGO	DESCRIPCIÓN	APLICACIÓN	MATERIA PRIMA	TERMINADO	POTENCIA MÁX. (W)	VOLTAJE (RANGO)	VAC-HZ	IP	VIDA PROMEDIO (h)	ÁNGULO DE APERTURA	LUMENS	IRC	TEMPERATURA	CORTE DE EMPOTRAMIENTO
8120-LED	LUMINARIA LED PARA EMPOTRAR EN PISO	EXTERIOR	ACERO INOX / CRISTAL	ACERO INOXIDABLE	1 W	100-240 V~	50-60 Hz	67	30000 h	28°	80 lm	80	3 000 K	Ø 6.3 cm
7120-LED	LUMINARIA LED PARA EMPOTRAR EN PISO	EXTERIOR	ACERO INOX / CRISTAL	ACERO INOXIDABLE	3 W	100-240 V~	50-60 Hz	67	30000 h	25°	213 lm	80	3 000 K	Ø 12.3 cm

PRODUCTO NUEVO



3850-LED

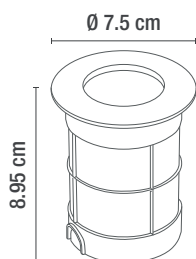

PRODUCTO NUEVO



6650-LED

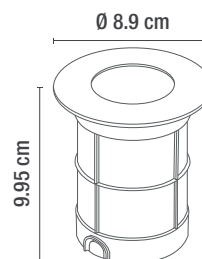

CÓDIGO	DESCRIPCIÓN	APLICACIÓN	MATERIA PRIMA	TERMINADO	POTENCIA MÁX. (W)	VOLTAJE (RANGO)	VAC-HZ	IP	VIDA PROMEDIO (h)	ÁNGULO DE APERTURA	LUMENS	IRC	TEMPERATURA	CORTE DE EMPOTRAMIENTO
3850-LED	LUMINARIA LED PARA EMPOTRAR EN PISO	EXTERIOR	ACERO INOX	ACERO INOXIDABLE	3 W	100-240 V~	50-60 Hz	67	15000 h	20.4	220	80	3000 K	Ø 6.5 cm
6650-LED	LUMINARIA LED PARA EMPOTRAR EN PISO	EXTERIOR	ACERO INOX	ACERO INOXIDABLE	6 W	100-240 V~	50-60 Hz	67	15000 h	19.6	500	80	3000 K	Ø 7.9 cm



5120-LED

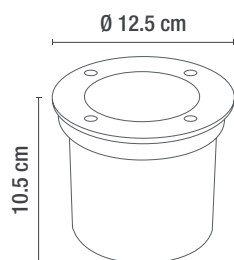

5020-LED

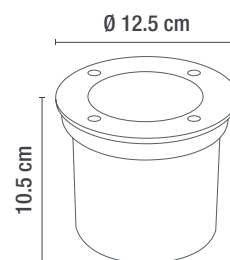

CÓDIGO	DESCRIPCIÓN	APLICACIÓN	MATERIA PRIMA	TERMINADO	POTENCIA MÁX. (W)	VOLTAJE (RANGO)	VAC-HZ	IP	VIDA PROMEDIO (h)	ÁNGULO DE APERTURA	LUMENS	IRC	TEMPERATURA	CORTE DE EMPOTRAMIENTO
5120-LED	LUMINARIA LED PARA EMPOTRAR EN PISO	EXTERIOR	ACERO INOX / CRISTAL	ACERO INOXIDABLE	6 W	100-240 V~	50-60 Hz	67	30000 h	25°	450 lm	80	3 000 K	Ø 11 cm
5020-LED	LUMINARIA LED PARA EMPOTRAR EN PISO	EXTERIOR	ACERO INOX / CRISTAL	ACERO INOXIDABLE	7 W	100-240 V~	50-60 Hz	67	30000 h	110°	597 lm	80	3 000 K	Ø 11 cm

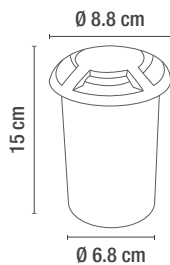

3180

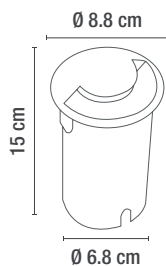

3190



3180

CÓDIGO	DESCRIPCIÓN	APLICACIÓN	MATERIA PRIMA	TERMINADO	POTENCIA MÁX. (W)	VOLTAJE (RANGO)	VAC-HZ	IP	CORTE DE EMPOTRAMIENTO	TIPO DE SOCKET	No. DE SOCKET
3180	LUMINARIA PARA EMPOTRAR EN PISO	EXTERIOR	ACERO INOX	INOXIDABLE	35 W	127 V~	50-60 Hz	65	Ø 6.8 cm	GU10	1
3190	LUMINARIA PARA EMPOTRAR EN PISO	EXTERIOR	ACERO INOX	INOXIDABLE	35 W	127 V~	50-60 Hz	65	Ø 6.8 cm	GU10	1



7371

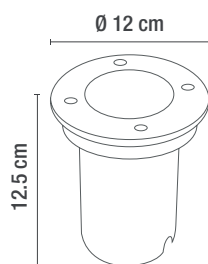

7371GX53

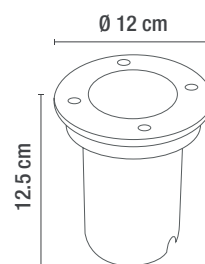

7372

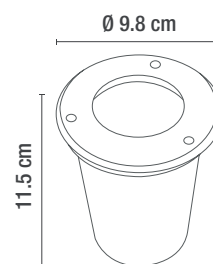

CÓDIGO	DESCRIPCIÓN	APLICACIÓN	MATERIA PRIMA	TERMINADO	POTENCIA MÁX. (W)	VOLTAJE (RANGO)	VAC-HZ	IP	CORTE DE EMPOTRAMIENTO	TIPO DE SOCKET	No. DE SOCKET
7371	LUMINARIA PARA EMPOTRAR EN PISO	EXTERIOR	ALUMINIO / CRISTAL	ACERO INOXIDABLE	35 W	127 V~	50-60 Hz	65	Ø 10.2 cm	GU10	1
7371GX53	LUMINARIA PARA EMPOTRAR EN PISO	EXTERIOR	ALUMINIO / CRISTAL	ACERO INOXIDABLE	35 W	127 V~	50-60 Hz	65	Ø 10.2 cm	GX5.3	1
7372	LUMINARIA PARA EMPOTRAR EN PISO	EXTERIOR	ALUMINIO / ACERO	ACERO INOXIDABLE	35 W	127 V~	50-60 Hz	65	Ø 8.8 cm	GU10	1

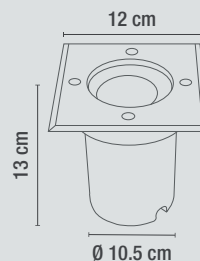

7280

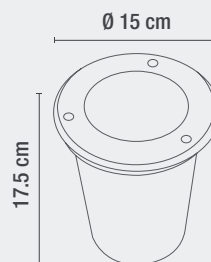

7450



CÓDIGO	DESCRIPCIÓN	APLICACIÓN	MATERIA PRIMA	TERMINADO	POTENCIA MÁX. (W)	VOLTAJE (RANGO)	VAC-HZ	IP	CORTE DE EMPOTRAMIENTO	TIPO DE SOCKET	No. DE SOCKET
7280	LUMINARIA PARA EMPOTRAR EN PISO	EXTERIOR	ACERO INOX / CRISTAL	INOXIDABLE	35 W	127 V~	50-60 Hz	67	Ø 10.5 cm	GU10	1
7450	LUMINARIA PARA EMPOTRAR EN PISO	EXTERIOR	ACERO INOX / CRISTAL	INOXIDABLE	60 W	127 V~	50-60 Hz	65	Ø 13.8 cm	E27	1



0920-LED/GF



0720-LED

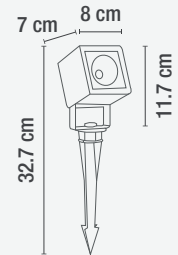

0920-LED/GF

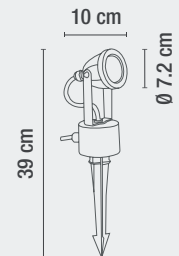

CÓDIGO	DESCRIPCIÓN	APLICACIÓN	MATERIA PRIMA	TERMINADO	POTENCIA MÁX. (W)	VOLTAJE (RANGO)	VAC-HZ	IP	VIDA PROMEDIO (h)	ÁNGULO DE APERTURA	LUMENS	IRC	TEMPERATURA
0720-LED	LUMINARIA LED PARA JARDÍN CON ESTACA	EXTERIOR	ALUMINIO / CRISTAL	GRAFITO	7 W	100-240 V~	50-60 Hz	65	30000 h	39°	602 lm	80	3 000 K
0920-LED/GF	LUMINARIA LED PARA JARDÍN CON ESTACA	EXTERIOR	ALUMINIO / CRISTAL	GRAFITO	7 W	100-240 V~	50-60 Hz	65	30000 h	39°	400 lm	82	3 000 K



6300



6300



CÓDIGO	DESCRIPCIÓN	APLICACIÓN	MATERIA PRIMA	TERMINADO	POTENCIA MÁX. (W)	VOLTAJE (RANGO)	VAC-HZ	IP	CORTE DE EMPOTRAMIENTO	TIPO DE SOCKET	No. DE SOCKET
6300	LUMINARIA PARA JARDÍN CON ESTACA	EXTERIOR	ALUMINIO / CRISTAL	NEGRO	35 W	127 V~	50-60 Hz	54	GU10	1	1



4550-LED/GF



4520-LED

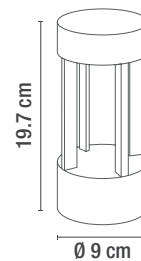

4550-LED/GF

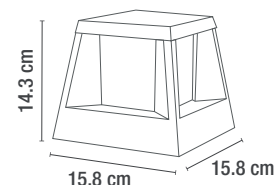

MU0204-LED/GF

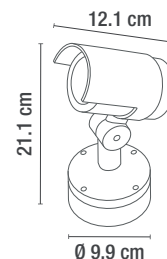

CÓDIGO	DESCRIPCIÓN	APLICACIÓN	MATERIA PRIMA	TERMINADO	POTENCIA MÁX. (W)	VOLTAJE (RANGO)	VAC-HZ	IP	VIDA PROMEDIO (h)	ÁNGULO DE APERTURA	LUMENS	IRC	TEMPERATURA
4520-LED	MINI POSTE LED PARA SOBREPONER EN PISO	EXTERIOR	ALUMINIO / CRISTAL	GRAFITO	7 W	100-240 V~	50-60 Hz	54	30000 h	41°	419 lm	80	3 000 K
4550-LED/GF	MINI POSTE LED PARA SOBREPONER EN PISO Y MURO	EXTERIOR	ALUMINIO / ACRÍLICO	GRAFITO	8 W	100-240 V~	50-60 Hz	65	30000 h	138°	275 lm	80	4 000 K
MU0204-LED/GF	MINI POSTE LED PARA SOBREPONER EN PISO Y MURO	EXTERIOR	ALUMINIO / CRISTAL	GRAFITO	20 W	127 V~	50-60 Hz	65	30000 h	44°	1283 lm	N/I	3 000 K



0860-LED/GR

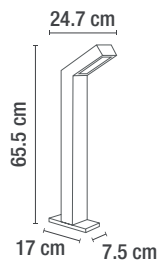

0861-LED/GF



0861-LED/GF



CÓDIGO	DESCRIPCIÓN	APLICACIÓN	MATERIA PRIMA	TERMINADO	POTENCIA MÁX. (W)	VOLTAJE (RANGO)	VAC-HZ	IP	VIDA PROMEDIO (h)	ÁNGULO DE APERTURA	LUMENS	IRC	TEMPERATURA
0860-LED/GR	MINI POSTE DE LED	EXTERIOR	ALUMINIO	GRIS	9 W	100-240 V~	50-60 Hz	54	30000 h	79°	169 lm	80	3 000 K
0861-LED/GF	MINI POSTE DE LED	EXTERIOR	ALUMINIO	GRAFITO	10 W	100-130 V~	50-60 Hz	54	30000 h	51°	645 lm	80	3 000 K

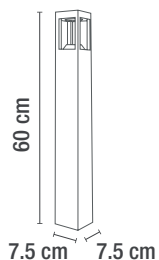

4620-LED



4820-LED



CÓDIGO	DESCRIPCIÓN	APLICACIÓN	MATERIA PRIMA	TERMINADO	POTENCIA MÁX. (W)	VOLTAJE (RANGO)	VAC-HZ	IP	VIDA PROMEDIO (h)	ÁNGULO DE APERTURA	LUMENS	IRC	TEMPERATURA
4620-LED	MINI POSTE DE LED	EXTERIOR	ALUMINIO	GRAFITO	7 W	100-130 V~	50-60 Hz	54	30000 h	43°	400 lm	80	3 000 K
4820-LED	MINI POSTE DE LED	EXTERIOR	ALUMINIO	GRAFITO	7 W	100-240 V~	50-60 Hz	54	30000 h	41°	420 lm	80	3 000 K

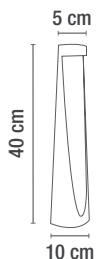

4920-LED



4920-LED

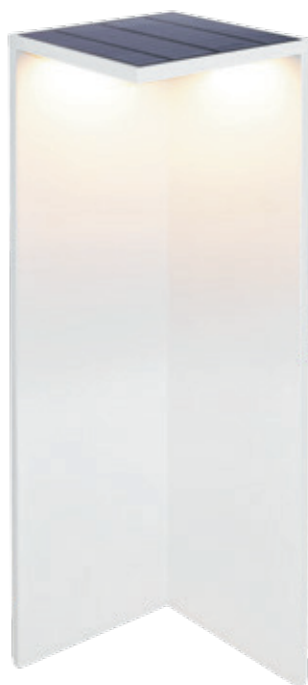
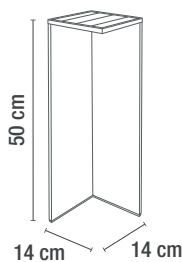

CL-8000-LED/BL



CL-8000-LED/BL



CÓDIGO	DESCRIPCIÓN	APLICACIÓN	MATERIA PRIMA	TERMINADO	POTENCIA MÁX. (W)	VOLTAJE (RANGO)	WAC-HZ	IP	VIDA PROMEDIO (h)	ÁNGULO DE APERTURA	LUMENS	IRC	TEMPERATURA
4920-LED	MINI POSTE DE LED PARA SOBREPONER EN PISO	EXTERIOR	ALUMINIO	GRAFITO	7 W	100-240 V~	50-60 Hz	65	30000 h	50°	303	80	3 000 K
CL-8000-LED/BL	MINI POSTE LED SOLAR CON SENSOR DE MOVIMIENTO PARA PISO	EXTERIOR	ALUMINIO	BLANCO	2.2 W	3.7 V DC	N/A	54	40000 h	280°	Intensidad 100%: 284lm, Intensidad 15%: 42lm	80	3 000 K

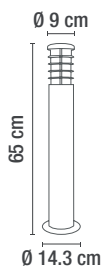

8363-650

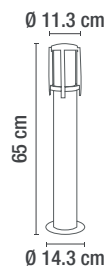

8383-650



CÓDIGO	DESCRIPCIÓN	APLICACIÓN	MATERIA PRIMA	TERMINADO	POTENCIA MÁX. (W)	VOLTAJE (RANGO)	VAC-HZ	IP	TIPO DE SOCKET	No. DE SOCKET
8363-650	MINI POSTE	EXTERIOR	ALUMINIO / CRISTAL	GRAFITO	20 W	127 V~	50-60 Hz	54	E27	1
8383-650	MINI POSTE	EXTERIOR	ALUMINIO / CRISTAL	GRAFITO	20 W	127 V~	50-60 Hz	54	E27	1

8103-450



8103-450

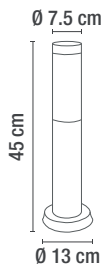

8113-450

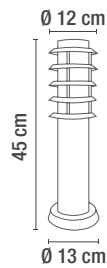

CÓDIGO	DESCRIPCIÓN	APLICACIÓN	MATERIA PRIMA	TERMINADO	POTENCIA MÁX. (W)	VOLTAJE (RANGO)	VAC-HZ	IP	TIPO DE SOCKET	No. DE SOCKET
8103-450	MINI POSTE	EXTERIOR	ACERO INOX / POLICARBONATO	INOXIDABLE	40 W	127 V~	50-60 Hz	54	E27	1
8113-450	MINI POSTE	EXTERIOR	ACERO INOX / POLICARBONATO	INOXIDABLE	40 W	127 V~	50-60 Hz	44	E27	1



Hecho en México

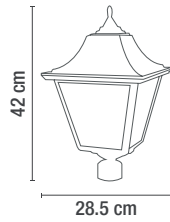

Uso con poste de Ø 2.5"

1603N



Hecho en México

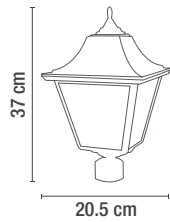

Uso con poste de Ø 2.5"

1503N



Hecho en México

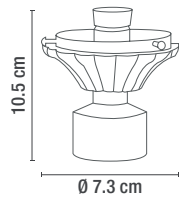

Uso con poste de Ø 2.5"

PPG/N



Hecho en México

1700/N

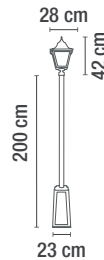

Hecho en México

PE1700N

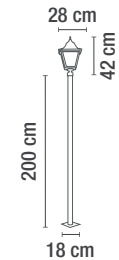

CÓDIGO	DESCRIPCIÓN	APLICACIÓN	MATERIA PRIMA	TERMINADO	POTENCIA MÁX. (W)	VOLTAJE (RANGO)	VAC-HZ	IP	TIPO DE SOCKET	No. DE SOCKET
1603N	LUMINARIO FAROL	EXTERIOR	ALUMINIO / CRISTAL	NEGRO	60 W	125 V~	50-60 Hz	54	E27	1
1503N	LUMINARIO FAROL	EXTERIOR	ALUMINIO / CRISTAL	NEGRO	60 W	125 V~	50-60 Hz	54	E27	1
PPG/N	PUNTA DE TUBO/ BASE PARA GLOBO R8 Y R10	EXTERIOR	ALUMINIO FUNDIDO / N/A	NEGRO	60 W	125 V~	50-60 Hz	54	E27	1
1700/N	POSTE FAROL CON CABEZAL Y BASE	EXTERIOR	POSTE ACERO, FAROL ALUMINIO / CRISTAL	NEGRO	60 W	125 V~	50-60 Hz	54	E27	1
PE1700N	POSTE FAROL CON CABEZAL Y PLACA	EXTERIOR	POSTE ACERO, FAROL ALUMINIO / CRISTAL	NEGRO	60 W	125 V~	50-60 Hz	54	E27	1



1705

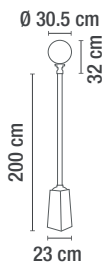

PE1705N

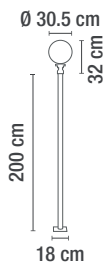

PE1702N

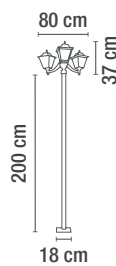

1702/N

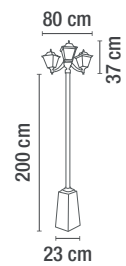

CÓDIGO	DESCRIPCIÓN	APLICACIÓN	MATERIA PRIMA	TERMINADO	POTENCIA MÁX. (W)	VOLTAJE (RANGO)	VAC-HZ	IP	TIPO DE SOCKET	No. DE SOCKET
1705	POSTE FAROL CON CABEZAL R12 Y BASE	EXTERIOR	POSTE ACERO, FAROL ALUMINIO / CRISTAL OPALINO / PMMA	NEGRO/VERDE	60 W	125 V~	50-60 Hz	54	E27	1
PE1705N	POSTE FAROL CON OPALINO Y PLACA R12	EXTERIOR	POSTE ACERO, FAROL ALUMINIO / CRISTAL OPALINO R12 / PMMA	NEGRO	60 W	125 V~	50-60 Hz	54	E27	1
PE1702N	POSTE FAROL CON CABEZAL Y PLACA	EXTERIOR	POSTE ACERO, FAROL ALUMINIO / CRISTAL / PMMA	NEGRO	180 W	125 V~	50-60 Hz	54	E27	3
1702/N	POSTE FAROL CON CABEZAL, PLACA Y BASE	EXTERIOR	POSTE ACERO, FAROL ALUMINIO / CRISTAL / PMMA	NEGRO	180 W	125 V~	50-60 Hz	54	E27	3

CÓDIGO	PÁGINA	CÓDIGO	PÁGINA	CÓDIGO	PÁGINA
1705	195	0720-LED	186	2520-LED/GF	144
3112	126	0860-LED/GR	189	2531-3	69
3180	183	0861-LED/GF	189	2620-LED	145
3190	183	0920-LED/GF	186	2820-LED	144
4100	126	1020-LED/GF	131	2920-LED	143
4101	126	1025-LED/GF	132	3015-GU10/GF	157
4542	168	1026-LED/GF	132	3020-LED	171
4544	60	1027-LED/BL	135	3021-LED	171
5471	150	1028-LED/BL	135	3081-GU10/GF	157
5481	151	1120-LED/GF	128	3082-GU10/GF	159
6300	187	1220-LED/GF	128	3320-LED	100
6501	168	1220-LED/GR	128	3420-LED	100
6502	167	1501N	166	3520-LED	99
6504	60	1503N	194	3620-LED	99
6512	167	1601N	166	3720-LED	99
7040	164	1603N	194	3820-LED/GF	141
7280	185	1620-LED/B	129	3825F-LED/BL	77
7371	184	1620-LED/GF	129	3826F-LED/BL	77
7372	184	1620-LED/GR	129	3827N-LED/BL	77
7450	185	1640-LED/GF	142	3850-LED	181
8102	163	1700/N	194	4020-LED/B	105
8112	163	1702/N	195	4020-LED/G	105
8143	148	1712-LED/GR	106	4231-LED/GF	102
8144	148	1720-LED/GF	130	4232-LED/GF	102
8146	164	1720-LED/GR	130	4320-LED	145
8148	148	2009-E27/GF	149	4500-1-GU10/SA	118
8362	162	2011-GU10/GF	159	4500-3-GU10/SA	118
8382	162	2012-E27/GF	149	4520-LED	188
96291	108	2013-GU10/GF	159	4550-LED/GF	188
5001/B	76	2220-LED	106	4620-LED	190
0120-LED	98	2520-LED	144	4720-LED	103
0220-LED	98	2520-LED/B	144	4720-LED/BL	103

CÓDIGO	PÁGINA	CÓDIGO	PÁGINA	CÓDIGO	PÁGINA
4820-LED	190	6041/O	166	8373S-E27/GF	161
4920-LED	191	6042/GF	165	8383-650	192
5001/N	76	6043/GF	165	8420-LED/GF	137
5011/B	76	6043/NE	165	8520-LED	138
5011/N	76	6220-LED/GF	177	8620-LED/GF	133
5020-LED	182	6315-GU10/GF	155	8720-LED/GF	133
5021/B	76	6316-GU10/GF	155	8820-LED	136
5021/N	76	6363-GU10/GF	155	8920-LED/GR	104
5031/B	76	6650-LED	181	9020-LED	104
5031/N	76	7020-LED	179	9220-LED	101
5120-LED	182	7031-A	156	9221-LED	101
5192/G	147	7032-A	156	9268-GU10/BL	152
5192/GF	147	7033-A	156	9268-GU10/GF	152
5192/N	147	7120-LED	180	9270-GU10/BL	153
5194/G	147	7320-LED	179	9270-GU10/GF	153
5194/N	147	7371GX53	184	9271-GU10/BL	154
5220-LED/GF	141	7420-LED	131	9271-GU10/GF	154
5225-LED/GF	140	7615-GU10/BL	85	9272-GU10/GF	153
5226-LED/GF	140	7635-GU10/GF	85	9273-GU10/GF	158
5320-LED/GF	141	7640-GU10/GF	85	9274-GU10/BL	153
5462/GF	147	7650-LED/GF	177	9274-GU10/GF	153
5464/GF	150	7720-LED	83	9281-GU10/BL	152
5466/GF	146	7820-LED/BL	145	9281-GU10/GF	152
5481/BL	151	7820-LED/GF	145	9282-GU10/GF	158
5482/BL	151	7920-LED	83	9283-GU10/BL	154
5482/GF	151	8103-450	193	9283-GU10/GF	154
5491/GF	146	8113-450	193	9420-LED/GF	138
5520-LED	129	8120-LED	180	94938-5+3	69
5720-LED/BL	139	8320-LED/B	137	94991/ONIX/O	111
5720-LED/GF	139	8320-LED/GF	137	9520-LED	130
5721-LED/BL	139	8363-650	192	9520-LED/GF	130
6041/N	166	8372/GF	161	9620-LED	136

CÓDIGO	PÁGINA	CÓDIGO	PÁGINA	CÓDIGO	PÁGINA
96233-3	70	C081/NE	27	C2038-6/CR	16
96235-5	70	C082/NE	25	C2038-6/NE	16
96239-3+6	70	C083/NE	28	C2040-6/BL	20
A1081-1	111	C084/NE	24	C2040-6/NE	20
A2028-1/CO	110	C090/HU	42	C2040-6/OR	20
A2028-1/S	108	C091/AB	47	C2050-8/BL	17
AE714/B	74	C091/HU	48	C2050-8/NE	17
AFG06/OX	107	C092/CR	53	C2050-8/OR	17
AFK1L/O	110	C096-3/CR	49	C2060-16/NE	21
AJB11-12	108	C096/CR	49	C2080-8/LC	19
AM6B	169	C098/CR	51	C2080-8/NE	19
AM6N	169	C098/HU	51	C217/ORM	41
AS1L/CH	109	C108-R8/BL	52	C218/ORM	41
AS1L/S	109	C108-R8/CR	52	C219/BL	34
BC6/BL	169	C108-R8/NE	52	C219/NE	34
BC6/N	169	C1083-3	67	C222/BL	36
BL24	73	C1084-5	67	C222/NE	36
BL24-CH	73	C1086-3+6	67	C223/NE	35
BR6/B	75	C110-R10/BL	52	C224/RO	36
BR6/N	75	C110-R10/CR	52	C226/BL	35
C003-E27/AB	45	C110-R10/NE	52	C226/NE	35
C060/NE	31	C117-E27/NE	45	C227/NE	32
C061/NE	32	C2025-5/CO	66	C301/NE-3	46
C070/AB	44	C2025-5/S	68	C302/NE-3	26
C071/AB	44	C2027-3/CO	66	C3022-6/BRZ	15
C072/AB	44	C2027-3/S	68	C303/NE-3	28
C076/NE	25	C2028-4/N	22	C304/NE	43
C077/NE	30	C2029-5/GR	22	C305/HU	43
C077/NE-3	30	C2030-8/NE	21	C306/CR	43
C078/NE	27	C2031-4/GR	22	C307/HU	42
C079/NE	26	C2035-3/CR	78	C308/NE	31
C080/NE	27	C2036-10/NE	15	C309/HU-3	48

CÓDIGO	PÁGINA	CÓDIGO	PÁGINA	CÓDIGO	PÁGINA
C312/NE	29	CFT6LP/O	64	DLA030-16W/C	87
C313/NE-3	29	CFW6L/ONIX/O	62	DLA030-16W/F	87
C315/OR	50	CGDR	95	DLP032-12W/F	81
C317/OR-3	50	CIT3L/S	68	DLP035-12W/N	81
C342/NE	32	CL-0236-5-LED/SA	12	DLP036-18W/C	81
C351/HU	42	CL-1085-LED/CR	12	DLP036-18W/F	81
C361/NE-3	33	CL-1100-1-LED/SA	124	DLP040-12W/C	82
C362/NE	33	CL-1200-1-LED/CR	125	DLP040-12W/F	82
C365/BMB	57	CL-1200-1-LED/NE	125	DLP042-18W/C	82
C366/BMB	57	CL-1202-2-LED/CR	125	DLP042-18W/F	82
C367/BMB	58	CL-1203-3-LED/CR	117	DLP096LED-C/BL	80
C368/BMB	58	CL-1204-LED/SA	124	DLP096LED-F/NE	80
C369/BMB	58	CL-2000S-LED/BL	170	DLP098LED-F/BL	80
C370/NE	47	CL-3010-LED/BL	10	DLP098LED-F/NE	80
C372/HU-3	46	CL-3010-LED/GF	10	DLS010-6W/F	86
C3C601/AM	55	CL-3012-LED/NE	12	DLS010-6W/N	86
C601/AM	55	CL-3026-LED/CR	13	DLS011-9W/F	86
C701MB/AM	56	CL-6565-LED/CR	13	DLS011-9W/N	86
C701MC/AM	56	CL-8000-LED/BL	191	DLS012-12W/F	86
C901MB/AM	56	CL3011LED/BL	11	DLS012-12W/N	86
CCF023/ONIX	61	CL3011LED/NE	11	DLS014-18W/F	86
CFCP6L/O	63	CL3015LED/NE	11	DRA/N	169
CFD5L/CH	63	CX68	176	EM2010C-GU10/S	90
CFG5L/NE	24	DL006-6.5W/C	88	EM2015-E27/B	91
CFI12L/ONIX/O	62	DL006-6.5W/F	88	EM2015-E27/S	91
CFI5L/ONIX/O	61	DL007-18W/N	89	EM2015C-E27/B	91
CFI9L/ONIX/O	62	DL007-8W/N	89	EM2015C-E27/S	91
CFK5L/O	65	DL008-12W/F	88	EM2020-E27/B	90
CFM3L/O	65	DL012-12W/C	88	EM2020C-E27/B	90
CFM5L/O	65	DL012-12W/F	88	EM2020C-E27/S	90
CFS1261/O	63	DLA026-9W/C	87	EM5080C-E27/B	90
CFT3LP/O	64	DLA026-9W/F	87	EM5080C-E27/S	90

CÓDIGO	PÁGINA
F1090/CR	115
F1091/CR	115
F1092/CR	115
F1093-LED/CR	117
F1095-LED/SA	116
F2130-3W	116
FA199W-E27/C	94
FA199W-E27/F	94
GAVE	95
GU10SMD5W/C	94
GU10SMD5W/F	94
GX538W-E27/C	94
GX538W-E27/F	94
H2010/B	92
H2010/S	92
H4010/B	92
H4010/S	92
H5001/BL	92
H5010/B	92
H5010/S	92
HS-5013-3	78
HS-5015-1/BL	120
HS-5015-1/NE	120
HS-5015-2/BL	121
HS-5015-2/NE	121
HS-5015-3/BL	121
HS-5015-3/NE	121
HS-5016-1	123
HS-5017-2	123
HS-5018-3	123
HS-6020-1/NE	119
HS-6021-2/NE	119

CÓDIGO	PÁGINA
HS-6022-3/NE	119
HS-7040-1/NE	122
HS-8020-3/NE	122
JB11-12	72
JB11-16	72
JB11-9	72
LM3310-LED/BL	7
LM3310-LED/GF	7
MR16SMD5W/C	94
MR16SMD5W/F	94
MU0102/NE	157
MU0204-LED/GF	188
MU0306/GF	160
MU0319/OR	107
MU0408/GF	160
MU0905-LED/GF	142
MU1612-LED/GF	143
N450B	74
NE950/B	74
OXC120PQ/P	113
OXC200/P	112
OXC200PQ/B	112
OXC200PQ/P	112
OXG212/P	113
P145/CH	71
P185/CH	71
P45SMD4W/C	94
P611/CH	71
P811/CH	71
PE1700N	194
PE1702N	195
PE1705N	195

CÓDIGO	PÁGINA
PIT/S	23
PL500-LED/CR	79
PL506-LED/NE	79
PL800-LED/CR	79
PPG/N	194
RF-3522-LED	172
RF-3524-LED	172
RF-3526-LED	173
RF-3528-LED	173
S6061-LED	170
TD7931LED-C/BL	84
TD7933LED-C/NE	84
V2020	39
V2020/NE	39
V2021	53
V2023	54
V2024	40
V2024/NEG	40
V2025	54
V2032	38
V2046/OR	38
V2050	37
V2050/NE	37
V22154W/25	127
V22154W/35	127
V2750	23
VINDGD	95
VINT22-4WE27	93
VINT33-4WE27	93
VINT44-4WE27	93

DESCARGA NUESTRO
CATÁLOGO DIGITAL



DESCUBRE LOS
NUEVOS PRODUCTOS
DE LANZAMIENTO EN EL RESTO DEL AÑO



o visita
www.calux.com.mx



CALUX[®]
ILUMINA MEJOR

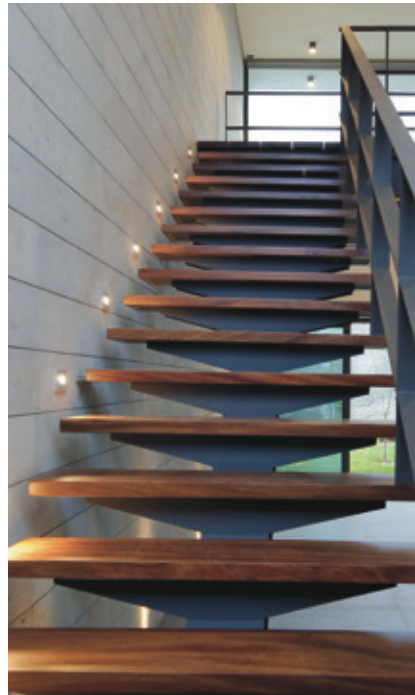

CALUX[®]
ILUMINA MEJOR

 [@calux](https://www.facebook.com/calux)  [@calux_ilumina](https://www.instagram.com/calux_ilumina)

www.calux.com.mx